



EUROPEAN  
PRODUCT  
DESIGN  
AWARD™  
2025 WINNER



# CATALOGUE 2026



**VERMEIREN**  
we care for you

# VERMEIREN

we care for you

**VERMEIREN**, manufacturer of wheelchairs since 1957, is a major player in the world of medical equipment. Over the years, the Vermeiren Group has specialized in producing wheelchairs, nursing beds, shell chairs, comfort chairs and any other product that may accompany a patient or user in maintaining his autonomy and mobility.



OUR COMPANY

The European development and design teams are equipped with precision high-tech tools, resulting in reliability and quality for each product Vermeiren produces. Today, Vermeiren is a group with more than 1300 employees with subsidiaries in Europe and Asia. Vermeiren delivers products for sale in more than 45 countries worldwide.





OUR COMPANY

International

**VERMEIREN nv**  
Vermeirenplein 1 / 15  
B-2920 Kalmthout  
website: [www.vermeiren.be](http://www.vermeiren.be)  
e-mail: [info@vermeiren.be](mailto:info@vermeiren.be)

**VERMEIREN Italia S.R.L.**  
Viale delle Industrie 5  
I-20020 Arese MI  
website: [www.vermeiren.it](http://www.vermeiren.it)  
e-mail: [info@vermeiren.it](mailto:info@vermeiren.it)

**VERMEIREN Medical Equipm. Co. Ltd.**  
18 Jiepu Road, SIP 215126 Suzhou  
Jiangsu Province - China  
website: [www.vermeiren.com.cn](http://www.vermeiren.com.cn)  
e-mail: [info@vermeiren.cn](mailto:info@vermeiren.cn)

**VERMEIREN Deutschland GmbH**  
Wahlerstraße 12 a  
D-40472 Düsseldorf  
website: [www.vermeiren.de](http://www.vermeiren.de)  
e-mail: [info@vermeiren.de](mailto:info@vermeiren.de)

**VERMEIREN Suisse S.A.**  
Eisenbahnstrasse 62  
3645 Gwatt (Thun)  
website: [www.vermeiren.ch](http://www.vermeiren.ch)  
e-mail: [info@vermeiren.ch](mailto:info@vermeiren.ch)

**VERMEIREN Nederland B.V.**  
p/a Vermeirenplein 1 / 15  
B-2920 Kalmthout  
website: [www.vermeiren.co.nl](http://www.vermeiren.co.nl)  
e-mail: [info@vermeiren.co.nl](mailto:info@vermeiren.co.nl)

**VERMEIREN France SAS**  
Rue de L'Empire  
F-59133 Phalempin  
website: [www.vermeiren.fr](http://www.vermeiren.fr)  
e-mail: [info@vermeiren.fr](mailto:info@vermeiren.fr)

**VERMEIREN Polska Sp. z o.o**  
ul. Łączna 1  
PL-55-100 Trzebnica  
website: [www.vermeiren.pl](http://www.vermeiren.pl)  
e-mail: [info@vermeiren.pl](mailto:info@vermeiren.pl)

**VERMEIREN Iberica, S.L.**  
Carretera de Cartellà, Km. 0,5  
Sant Gregori Parc Industrial, Edifici A  
17150 Sant Gregori (Girona)  
website: [www.vermeiren.es](http://www.vermeiren.es)  
e-mail: [info@vermeiren.es](mailto:info@vermeiren.es)

**VERMEIREN Austria GmbH**  
Schärldinger Straße 4  
A-4061 Pasching  
website: [www.vermeiren.at](http://www.vermeiren.at)  
e-mail: [info@vermeiren.at](mailto:info@vermeiren.at)

**VERMEIREN CR S.R.O.**  
Nádražní 132  
702 00 Ostrava 1  
website: [www.vermeiren.cz](http://www.vermeiren.cz)  
e-mail: [info@vermeiren.cz](mailto:info@vermeiren.cz)

**VERMEIREN India Rehab Pvt. Ltd.**  
#400, Red Sanders Boulevard,  
Sri City, Tirupathi District,  
Andhra Pradesh - Pin: 517646  
website: [www.vermeiren.in](http://www.vermeiren.in)  
e-mail: [info@vermeiren.in](mailto:info@vermeiren.in)



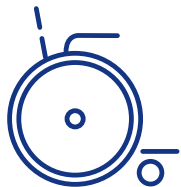

ACTIVE MANUAL WHEELCHAIRS

pag. 09

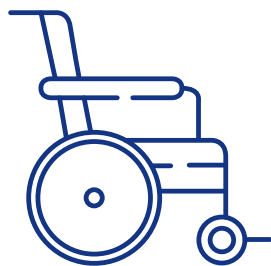

STANDARD & LIGHT MANUAL WHEELCHAIRS

pag. 25



POWERED WHEELCHAIRS

pag. 53

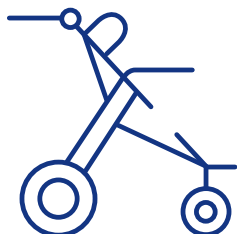

KIDS WHEELCHAIRS

pag. 79



COMFORT WHEELCHAIRS

pag. 95

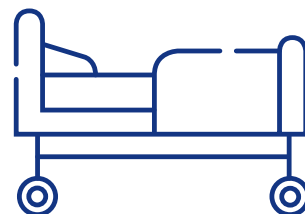

BED & HOMECARE PRODUCTS

pag. 105



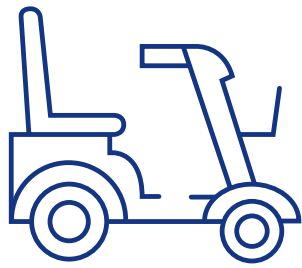

### SCOOTERS

pag. 125

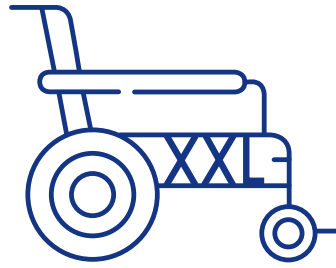

### BARIATRIC PRODUCTS

pag. 143

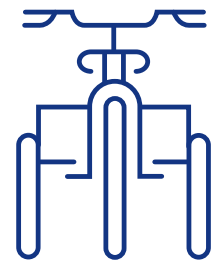

### TRICYCLES

pag. 153

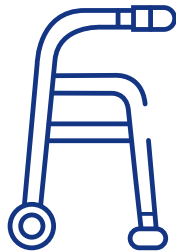

### WALKING ASSISTANTS

pag. 163



### BATHROOM & DAILY USAGE

pag. 171

This catalogue represents products that are being brought to you by the **VERMEIREN group**. Kindly be informed that some products shown in this catalogue may not be available in your country.

Please contact your regional reseller for more up to date information on which products are available in your region.

For more detailed information, visit us at [www.vermeiren.com](http://www.vermeiren.com)





01 \ ACTIVE MANUAL WHEELCHAIRS



## ACTIVE MANUAL WHEELCHAIRS

V500 Active	10
Trigo S	14
Trigo T	18
Trigo Kids	20
Sagitta	21
Sagitta kids	22

**VERMEIREN** has designed active wheelchairs to be an extension of your **body**. Ideal for people with good upper body strength and core stability. Colorful, bright, with a wide range of options to customize your active wheelchair. Depending on your needs, we can provide you with a wheelchair that perfectly fits your active lifestyle.

# V500 ACTIVE



V500 ACTIVE

LIGHTWEIGHT ACTIVE WHEELCHAIR

# V500 Active

## PERSONALIZATION

Introducing the V500 Active wheelchair, built upon the successful concept of the V500 family. This cutting-edge model brings a plethora of options and accessories, catering to diverse needs, including the most advanced requirements. Designed for ultimate user personalization, the V500 Active offers high configurability, ensuring a perfect fit for every individual.



## LIGHT - FROM 11,9 KG

Through our efforts, we have successfully crafted an exceptionally lightweight model, weighing in at an impressive 11.9 kg. This remarkable outcome showcases our commitment to innovation and delivering a wheelchair that not only looks dynamic but also offers enhanced mobility and ease of use.

## FUSION

Embracing an active and modern aesthetic, it appeals to those who seek a stylish and dynamic appearance. Experience the ideal fusion of comfort and adaptability found in a standard wheelchair, seamlessly combined with the sleekness and agility of an active folding chair. The V500 Active strikes the perfect balance, offering an unparalleled mobility solution that empowers users in their daily activities.



# V500 Active

ACTIVE FOLDABLE CHAIR



We offer more than 32 different colours. For more information, please check our website.

SCAN the QR code and discover the V500 Active.



Armrests come in a spectrum of options, ranging from sleek aluminium side guards to convenient, adjustable and removable armrests designed for utmost comfort. Whereas footrests and leg rests are offered in a diverse array of solutions, catering to various user requirements and adapting to their changing needs over time.

Embrace a spectrum of colours! Each shade we've carefully curated not only reflects our mood but also defines our way of life. Unlock the opportunity to choose from a variety of hues, allowing you to personalize your wheelchair and truly embody your uniqueness.

## Features



Adjustable seat angle



Adjustable seat height



Adjustable seat depth



Removable, in and outward folding footrests

## Technical information

■ Total width	590 - 620 - 640 - 660 - 680 - 700 mm
■ Total height when folded (depends on seat height)	740 - 840 mm
■ Total length	975 - 1035 mm
■ Folded width	310 mm
■ Seat width	390 - 420 - 440 - 460 - 480 - 500 mm
■ Seat height	440 requires 22" rear wheels - 470 - 500 - 530 mm

■ Height backrest	300 - 350 - 400 mm
■ Seat depth	420 - 440 - 460 - 480 mm
■ Weight (without cushion)	From 11,9 kg
■ Heaviest part	7,5 kg
■ Maximum user weight	130 kg
■ Additional info	CE

Measurements in mm and kg. Deviations in sizes and weight (1,5 mm and 1,5 kg) are possible. Subject to technical alterations. Images for illustration purposes only. Certain features may be optional.

# OPTIONS V500 Active



**Bi5A**  
Adjustable armrests  
in height



**BA6**  
Removable footrest,  
shorter version (6cm)



**BK6** One-piece  
footrest



**BK7** Leg rest for  
amputee



**BP7** Plaster leg  
legrest



**BZ7** articulated  
legrest self-correcting  
in length



**BZ10**  
Monoblock manual  
legrest with side corners



**PH01 - 06**  
Varieties in different  
push handles (fixed, foldable  
or height adjustable)



**Rear wheels**  
Variety in rear wheels (22"  
or 24") with colour accents



**Front wheels**  
Variety in front wheels (3"  
to 6") with colour accents



**LED front wheels**  
4" or 5"



**B85** Spoke protectors with  
several different designs



**Push brakes**



**Sports brakes**



**B24D** Folded cushion



**B33** Gel rim 24"



**B58** Safety belt  
with quick buckle



**B74**  
Drum brakes



**B78**  
Anti-tipping wheels



**B79**  
Document holder

■ Consult our order forms to discover all the possible options on [www.vermeiren.com](http://www.vermeiren.com) ■

# Trigo s

ACTIVE FOLDABLE CHAIR



We offer more than 32 different colours. For more information, please check our website.

SCAN the QR code and watch the Trigo movie.



The TRIGO S is a stylish, lightweight, and adaptable wheelchair, thoughtfully designed for those who value mobility and independence.

Sporty and modern looking rear wheels (quick adjust angle and height wheels) with easily accessible brakes and small front casters (height adjustable) from 3" to 6".

The TRIGO S is supplied with a fixed base plate, a height-adjustable side guard and the supports are integrated into the frame. The centre of gravity of the wheelchair can be adapted to the needs of each user.

We designed the Trigo range to be contemporary while catering to everyone's individual taste. Your Trigo can be fully customised to order.

## Features



Camber adjustment of the rear wheels



Height adjustable wheels



Triangular tubes



Adjusting the position of the rear wheels

## Technical information

■ Total width	460 / 660 mm
■ Total length	676 - 1046 mm
■ Total height	457 - 945 mm
■ Seat / footrest angle	70°/80°/90°
■ Seat width	300 / 500 mm
■ Seat inclination	20°

■ Seat height	380 - 510 mm
■ Backrest height	250 - 500 mm
■ Seat depth	320 - 500 mm
■ Weight	>11 kg
■ Maximum user weight	70 - 130 kg
■ Additional information	CE

Measurements in mm and kg. Deviations in sizes and weight (15 mm and 1,5 kg) are possible. Subject to technical alterations. Images for illustration purposes only. Certain features may be optional.

# OPTIONS Trigo S - Trigo T



**B82-S or B82-C fixed adjustable fixed clothing protectors, in aluminum or carbon**



**B82 fixed adjustable fixed aluminum clothing protectors with mudguards**



**Bi5 adjustable armrests in height**



**Tube tube armrests retractable to the back**



**B82SL-A long aluminum clothing protectors, removable**



**B82L-A removable and adjustable long clothing protectors with mudguards, aluminum material**



**B82S-C removable and adjustable clothing protectors in carbon**



**B82-C removable and adjustable clothing protectors with mudguards in carbon**



**Front wheel standard, black 3", 4", 5", 6"**



**Transparent wheel 3", 4", 5", 6"**



**Silver aluminum wheel 3", 4", 5"**



**Blue aluminum wheel 3", 4", 5",**



**Red aluminum wheel 3", 4", 5"**



**Carbon wheel 4", 5"**



**LED wheel 4", 5"**



**Standard rear wheel 18"**



**Rear wheel - Design 20", 22" 24", 26"**



**Rear wheel - Spirit - with aluminium hub 24"**



**Rear wheel - Spirit - with red hub 24"**



**Rear wheel - Spirit - with blue hub 24"**

## OPTIONS Trigo S - Trigo T



**Rear wheel - Off Road  
24"**



**Rear wheel Right Run  
Black - Available with  
Design and Spirit wheels**



**Rear wheel Marathon  
Plus - Available with  
Design and Spirit wheels**



**B85 Spoke protector**



**Push or  
pull brakes**



**Sport brakes**



**Traditional brakes with  
retractable handles (B40)**



**B31L/R Crutch holder  
left or right**



**B78 Anti-tipping  
wheel - left or right**



**B86  
Travel wheels**



**B90 Stabilisation bar  
for the backrest**



**Neoflex belts  
check all of our belts on  
[www.vermeiren.com](http://www.vermeiren.com)**



**LO4 L lateral supports  
left or right (large version)**



**LO4 S lateral supports  
left or right (small version)**



**B74  
Drum brakes**



**BA6 footrest  
shortened by 5 cm**



**B06  
Removable and  
swing-away footrest**



**BK6  
Single piece footplate**



**BK7  
Amputee support  
(adjustable in height)**



**BZ8  
Articulated legrest  
self-correcting in length**

## OPTIONS Trigo S - Trigo T



**Single footrest**  
Trigo S



**Single piece**  
Carbon plate, foldable



**Single piece**  
with retractable plate



**Single piece tube**  
aluminium frame



**Reversed footplate**  
for shorter legs



**Foldable footrest**  
with plate



**Closed Frame 70°**  
(angled foot rest)



**Closed Frame 80°**  
(angled foot rest)



**Closed Frame 90°**  
(angled foot rest)



**B20**  
Safety belt

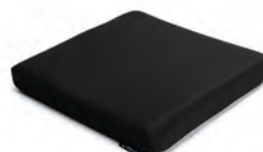

**B24TR**  
Cushion 6 cm

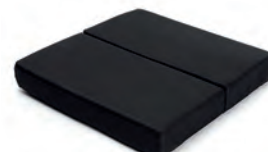

**B24D**  
Cushion 6 cm  
divided



**5 cm cushion**  
made from Visco material



**B33**  
Gel cover for push rim



**B330**  
Push rim with soft cover



**B330A**  
Push rim with soft cover  
advanced grip



**B40**  
Brake lever extension



**B47**  
Height-adjustable head rest



**B12**  
Wooden table



**B66MAL**  
Guttered armrest

■ Consult our order forms to discover all the possible options on [www.vermeiren.com](http://www.vermeiren.com) ■



# Trigo T

ACTIVE  
FOLDABLE CHAIR



We offer more than **32** different colours. For more information, please check our website.



SCAN the QR code and watch the Trigo movie.

Sporty and modern looking rear wheels (quick adjust wheels, which can be adjusted in angle and height) with easily accessible brakes and small front casters (adjustable in height) from 3" to 6".

The TRIGO T is equipped with adjustable and removable footrests. The center of gravity of the wheelchair can be adapted to the needs of each user.



## Features



Removable and swing away footrests



Foldable for easy transport



Double cross for enhanced stability



Removable rear wheels for easy transport

## Technical information

Total width	460 / 660 mm
Total length	676 - 1046 mm
Total height	457 - 945 mm
Seat / footrest angle	70°/80°/90°
Seat width	300 / 500 mm
Seat inclination	20°

Seat height	380 - 510 mm
Backrest height	250 - 500 mm
Seat depth	320 - 500 mm
Weight	>10 kg
Maximum user weight	70 - 130 kg
Additional information	CE

Measurements in mm and kg. Deviations in sizes and weight (1,5 mm and 1,5 kg) are possible. Subject to technical alterations. Images for illustration purposes only. Certain features may be optional.

## OPTIONS Trigo S - Trigo T



**B900**  
Stabilizing bar  
at the backrest



**Document pouch**  
at the backrest



**HEM2**  
Hemiplegic kit  
double rims



**Neoprene protection**  
for the front frame



**PH01**  
Push handles - fixed (12cm)



**PH02**  
Push handles - fixed short  
(8cm)



**PH03**  
Foldable push handles



**PH04**  
Height adjustable push handles  
Adjustment in backrest tubes  
fixed handle



**PH05** Height adjustable  
with clamps behind backrest  
fixed handles



**PH06** Height adjustable  
with clamps behind backrest  
foldable handles



**Fixed backrest**



**Adjustable backrest**  
inclination 82°-102°



**Foldable backrest**  
adjustable in inclination  
(82°-102°)



**L44** Tension adjustable  
backrest



**Fixed canvas**



**Adjustable canvas**  
tension adjustable

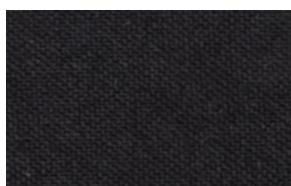

**Nylon backrest**

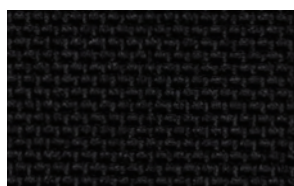

**Nylon Plus backrest**



**3D Net backrest**

■ Consult our order forms to discover all the possible options on [www.vermeiren.com](http://www.vermeiren.com) ■



# Trigo KIDS

ACTIVE LIGHT WHEELCHAIR FOR CHILDREN



We offer more than 32 different colours. For more information, please check our website.



SCAN the QR code and watch the Trigo movie.

The Trigo Kids is the mirror image of its adult counterpart. With its lively and bright colors, it offers you to create your own personal wheelchair with infinite adjustment possibilities.

Designed to be lightweight and foldable, Trigo Kids can be taken anywhere you like. Trigo Kids is an active wheelchair, especially designed for young people who enjoy staying mobile and active.

## Features



Optional LED colored front wheels



BZ8 leg rests for optimal comfort



B85 - Spoke protectors with several different designs

## Technical information

Total width	460 / 660 mm
Total length	676 - 1046 mm
Total height	457 - 945 mm
Seat - footrest angle	70°/80°/90°
Seat width	300 / 500 mm
Seat inclination	20°

Seat height	380 - 510 mm
Backrest height	250 - 500 mm
Seat depth	320 - 500 mm
Weight	>10 kg
Maximum user weight	70 - 130 kg
Additional information	CE

Measurements in mm and kg. Deviations in sizes and weight (1,5 mm and 1,5 kg) are possible. Subject to technical alterations. Images for illustration purposes only. Certain features may be optional.

# Sagitta

LIGHTWEIGHT  
ACTIVE CHAIR

**C20**  
blue

**C41**  
green

**C55**  
inox



We offer more than 32  
different colours.  
For more information,  
please check our website.



SCAN the QR code  
and discover the Sagitta.



The Sagitta is a modern, active wheelchair that can be fully personalised. Armrests, leg supports and adjustable dimensions are included.

The maximum weight is only 9.5 kg due to the solid frame made of light aluminium. Available in a wide range of colours, spoke protectors with colourful prints and a wide range of front and rear wheels.



## Features



Backrest tilt adjustment  
without tools



Available in SI-version  
with reclining seat



Adjustable wheel  
camber from 0° to 8°



Standard  
handbrakes

## Technical information

Total width	550 - 780 mm
Total length	755 - 855 mm
Total height	720 mm
Folded width	—
Seat width	360 - 460 mm
Armrest height	90 mm

Seat height	470 - 520 mm
Backrest height	230 - 430 mm
Seat depth	330 - 380 - 420 mm
Weight	11,7 kg
Maximum user weight	100 kg
Additional information	CE

Measurements in mm and kg. Deviations in sizes and weight (15 mm and 1,5 kg) are possible.  
Subject to technical alterations. Images for illustration purposes only. Certain features may be optional.

# Sagitta KIDS

LIGHTWEIGHT  
ACTIVE CHAIR



We offer more than **32**  
different colours.  
For more information,  
please check our website.

SCAN the QR code  
and discover the Sagitta.



**Sagitta Kids, the active wheelchair for children, has the same possibilities and advantages as its big brother Sagitta. Perfectly adapted to your child without adding unnecessary options.**

The frame has been designed to make the seat width very adaptable. With a backrest and seat tension adjustable, adjustable push bar, backrest inclination (adjustable without tools) and wheel camber from 0° to 8° the possibilities of

personalization are infinite. Combine those setting with a wide variety of colors and it results in a wheelchair adapted to your child, for all aspects of his youth.

## Features



**Tension adjustable backrest**



**Foldable backrest for easy transport**



**Fully configurable custom-made chair**

## Technical information

Total width	460 / 655 mm
Total length	700 - 750 mm
Total height (folded backrest)	440 mm
Folded width	—
Seat width	240 / 340 mm
Armrest height	120 mm

Seat height	370 - 428 mm
Backrest height	230 - 430 mm
Seat depth	280 - 300 - 320 mm
Weight	9 kg
Maximum user weight	60 kg
Additional information	CE

Measurements in mm and kg. Deviations in sizes and weight (15 mm and 1,5 kg) are possible. Subject to technical alterations. Images for illustration purposes only. Certain features may be optional.

# OPTIONS Sagitta



**B82 Clothing protectors**  
(standard)



**B82 Clothing protectors**  
with mudguard



**B82S mudguard**  
+ tube armrests



**Sport brakes**  
(scissor brakes)



**Footrest with**  
aluminium plate (kids)



**Footrest with**  
separated footplates



**Monoblock footrest**  
standard tube



**Monoblock footrest**  
with aluminum plate



**Push handles**  
adjustable in height



**Wheels 3"**  
translucent



**Wheels 4"**  
translucent



**Wheels 5"**  
translucent



**Wheels 3"**  
black



**Wheels 4"**  
black



**Wheels 5"**  
black



**B85 Spoke protector**  
M3 "Extreme"



**B85 Spoke protector**  
M1 "Flowers"



**B85 Spoke protector**  
M2 "Flowers"



**B85 Spoke protector**  
M3 "Pirate"



**B85 Spoke protector**  
with the Sagitta logo

■ Consult our order forms to discover all the possible options on [www.vermeiren.com](http://www.vermeiren.com) ■



02

STANDARD & LIGHT MANUAL WHEELCHAIRS



## STANDARD & LIGHT MANUAL WHEELCHAIRS

708D	26
101	29
Jazz S50	30
D100	31
D200	32
D200 Split	34
D200 30°	35
Eclips X4	36
Eclips X4 90°	37
V300 30°	38
V300	39
V300 DL	41
V500 Light	42
V500 Light 30°	44
Bobby	46
Bobby EVO	47
Physipro / B66MAL	48
Stabilo / V-Drive	49
Gel pads	50
Blumil	51

**VERMEIREN** is an expert in the field of mobility and offers a very wide range of wheelchairs for children and adults, from transfer chairs to custom-made active chairs.

Each chair is designed to offer the greatest possible comfort and a wide range of adjustments so that each chair can be fully adapted to its user and their needs.

# 708D

## STANDARD MANUAL WHEELCHAIR

C29  
grey



- 3 types of folding and removable armrests with long and comfortable armrests
- Wide range of options and accessories
  - Armrest locking system is easy to access and to operate
- Various seat and backrest options
  - Available in 6 seat widths
  - 4 types of footrests and 5 types of leg rests

**Aesthetics, reliability and functionality. All removable parts such as footrests, armrests, wheels and cushions can be replaced thanks to the modular system.**

The wide range of accessories and options allows the wheelchair to be optimally adapted to the user. Well known and recognized for its sturdiness and quality, the 708D makes an ideal asset for a rental fleet or or as a durable choice to own for a very long time.



### Features



**Aluminium footplates complete with rubber protection wheels**



**Easy to fold, easy to transport**



**Hemiplegic (HEM2) version. Double rims to propel and to steer**



**Amputee (AMP) version. Position of the rear wheel has shifted to the back**

### Technical information

■ Total width	560 / 590 / 610 / 630 / 650 / 670 mm
■ Total length	1109 mm
■ Total height	910 mm
■ Folded width	280 mm
■ Seat width	390 / 420 / 440 / 460 / 480 / 500 mm
■ Armrest height	225 mm

■ Seat height	490 mm
■ Backrest height	420 mm
■ Seat depth	430 mm
■ Weight	18 kg
■ Maximum user weight	120 kg
■ Additional information	

Measurements in mm and kg. Deviations in sizes and weight (15 mm and 1,5 kg) are possible. Subject to technical alterations. Images for illustration purposes only. Certain features may be optional.

# OPTIONS 708D



**B03** Long swing-away armrests



**B05** In height adjustable armrest



**BK6** One-piece footrest

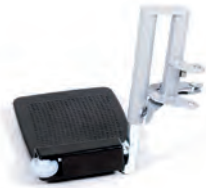

**BN6** Vertical shortened footrest



**BA6** Shortened footrest



**BZ8** Articulated legrest self-correcting in length



**BZ10** One-piece legrest with side supports



**L14 - L15** Anatomically shaped backrest and seat in artificial leather



**L14 - L15 soft** Anatomically shaped backrest and seat in soft artificial leather



**L24 - L25** Preshaped backrest and seat in soft or artificial leather



**B40** Brake lever extension



**L55** Artificial leather headrest, adjustable for chairs with anatomical backrest



**B12** Black wooden swing away table with cut-out



**B20** Safety belt with clip



**L04** Side supports



**B22** Spreader



**B31** Crutch holder



**B90** Push bar



**B78** Anti-tipping wheels



**B83** Oxygen cannister holder

■ Consult our order forms to discover all the possible options on [www.vermeiren.com](http://www.vermeiren.com) ■



# 101

## STANDARD MANUAL WHEELCHAIR FOR DAILY USAGE



**C86**  
carbon  
grey

- Practical for multi-purposes
- Two tipping pieces at the back to easily overcome obstacles
  - Internal and external collapsible footplates
- Foldable and removable armrests
- Rear wheels with Quickrelease system

We could give you 101 reasons why this **VERMEIREN** manual wheelchair is the best choice for permanent and temporary users. 101 is a strong foldable steel wheelchair with many added functionalities. Designed with a swing-away armrests, quick release axle, ergonomic armrests,... it provides ultimate comfort and useability for both user and attendant.



### Features



*Ergonomic handgrips*



*Quick release axle*



*Swing away armrests*



*Swing away and detachable footrests*

### Technical information

■ Total width	590 / 620 / 640 / 660 / 680 / 700 / 740 mm
■ Total length	1000 - 1210 mm
■ Total height	910 - 1015 mm
■ Folded width	300 mm
■ Seat width	390 / 420 / 440 / 460 / 480 / 500 / 550 mm
■ Armrest height	235 mm

■ Seat height	390 - 520 mm
■ Backrest height	420 - 460 mm
■ Seat depth	420 - 500 mm
■ Weight	19,5 kg
■ Maximum user weight	130 kg
■ Additional information	CE

Measurements in mm and kg. Deviations in sizes and weight (15 mm and 1,5 kg) are possible. Subject to technical alterations. Images for illustration purposes only. Certain features may be optional.

# Jazz S50

STANDARD  
MANUAL  
WHEELCHAIR



**C86**  
carbon  
grey

- Minimum folding width
- Soft padded armrests
- Quick-release rear wheels for a speedy disassembly
- 100% steel frame for extra durability
- Compact, stable and built to last

The wheelchair Jazz S50 is an excellent combination between technicality, comfort and VERMEIREN quality. Often seen as a standard wheelchair but with many adjustability options.

Ergonomic handgrips, easy to clean nylon upholstery, adjustable arm- and legrests and detachable rear wheels. The Jazz S50 can be equipped as transit model (T30) or extended with several options such as travelwheels, anti-tipping or a B05 armrest.

## Features



*Soft padded armrests*



*Easy removable footrests*



*Optional foldable backrest*



*Optional T30 wheels*

## Technical information

■ Total width	565 / 595 / 615 / 635 / 655 / 675 mm
■ Folded width	290 mm
■ Seat with	390 / 420 / 440 / 460 / 480 / 500 mm
■ Height armrests	220 mm
■ Seat height	500 mm
■ Height backrest	420 mm

■ Total height	935 mm
■ Seat depth	450 mm
■ Total length	1120 mm
■ Weight	16,6 kg
■ Users weight	130 kg
■ Additional info	

Measurements in mm and kg. Deviations in sizes and weight (15 mm and 1,5 kg) are possible. Subject to technical alterations. Images for illustration purposes only. Certain features may be optional.

# D100

## STANDARD MANUAL WHEELCHAIR

C29  
grey

- Height adjustable push handles
- Foldable and removable armrests
- Height and depth adjustable armrests
- Foldable and removable footrests
- Seat height adjustable in 3 positions
- Integrated adjustment of the rear axle



The **D100** is your ideal compact lightweight wheelchair for longterm or short term usage. **Completely foldable** (easy for transport when visiting places or when you need to store the wheelchair) and plenty of adjustment possibilities towards your own desires. We also offer an optional **BZ8** (articulated legrest, self-correcting in length) for extra leg support or a **B74** (drumbrakes operated by the accompanying person)



Ergonomic and height adjustable handgrips



Ergonomic push handbrakes



Adjustable armrests

### Technical information

■ Total width	580/600/620/640/660/680/700/720 mm
■ Total height	880 - 940 mm
■ Total length	1010 mm
■ Folded width	300 mm
■ Seat width	380/400/420/440/460/480/500/520 mm
■ Armrest height	220 - 240 mm

■ Seat height	470 - 530 mm
■ Height backrest	420 mm
■ Seat depth	430 mm
■ Weight	18 kg
■ Maximum user weight	130 kg
■ Additional information	 

Measurements in mm and kg. Deviations in sizes and weight (15 mm and 1,5 kg) are possible. Subject to technical alterations. Images for illustration purposes only. Certain features may be optional.

# D200

## STANDARD MANUAL WHEELCHAIR

**C86**  
carbon  
grey

- Available in 8 seat widths (from 38 to 52 cm)
- Height and depth adjustable armrests
  - Height adjustable push handles
  - Inwards and outwards swing-away and removable footrests
- Seat height adjustable in three positions
  - Padded seat and backrest
- In height and depth adjustable arm pads
  - Angle adjustable footrests



The D200 is a lightweight manual wheelchair made of aluminium. Foldable for easy transport and storage without compromising on adjustment possibilities. The new design and carbon colour give it a modern and agreeable look for all.

### Features



Height adjustable push handles



Padded seat and backrest



Adjustable front wheels



Two tipping pieces



Easy to fold and compact for transport and storage



### Technical information

Total width	580 / 600 / 620 / 640 / 660 / 680 / 700 / 720 mm
Total length	1010 mm
Total height	880 - 940 mm
Folded width	300 mm
Seat width	380 / 400 / 420 / 440 / 460 / 480 / 500 / 520 mm
Armrest height	220 - 240 mm

Seat height	470 - 530 mm
Backrest height	420 mm
Seat depth	430 mm
Weight	16,8 kg
Maximum user weight	130 kg
Additional information	

Measurements in mm and kg. Deviations in sizes and weight (15 mm and 1,5 kg) are possible. Subject to technical alterations. Images for illustration purposes only. Certain features may be optional.

OPTIONS D200 - D200 30°



**Bi5** Design armrest adjustable in height



**B66MAL** Guttet rotating armrest



**B03** Standard long armrests



**B06** Removable standard footrest



**BZ8** articulated legrest self-correcting in length 07 long - 08 short



**BK7** Legrest for amputees, left or right model



**BP7** Plaster leg legrest



**B14** Backrest extension



**B47** Standard adjustable headrest, for chairs with a nylon backrest



**B15A** Plastic table



**B20** Safety belt with clip



**B58** Quick-release seat belt



**B31** Crutch holder



**B40** Brake extensions



**B42** Removable shopping net



**B78** Anti-tipping wheels



**B90** Push bar



**B91** Anti-theft bar



**B52** Serum holder

■ Consult our order forms to discover all the possible options on [www.vermeiren.com](http://www.vermeiren.com) ■

# D200 SPLIT

MANUAL  
WHEELCHAIR  
SEMI-FOLDABLE  
BACKREST



**C86**  
carbon  
grey

- Brakes with locking function
- Comfortable removable 4 cm seating cushion
  - Semi-foldable backrest
  - Backrest and seat cushion in 3D NET upholstery
- Rear wheels with quick-release system
- Adjustable armrests

The D200 Split is a manual wheelchair made with a lightweight aluminum frame, quick-release wheels, and a stunning blue 3D net seat, and backrest.

The backrest can be folded backward for even more compactness when traveling.

## Features



Adjustable armrests



Brakes with locking function



Comfortable and breathable seating cushion



Height adjustable front wheels



## Technical information

■ Total width	580 / 600 / 620 / 640 / 660 / 680 / 700 / 720 mm
■ Total length	1010 mm
■ Total height	880 - 940 mm
■ Folded width	300 mm
■ Seat width	380 / 400 / 420 / 440 / 460 / 480 / 500 / 520 mm
■ Armrest height	220 - 240 mm

■ Seat height	470 - 530 mm
■ Backrest height	420 mm
■ Seat depth	430 mm
■ Weight	16,8 kg
■ Maximum user weight	130 kg
■ Additional information	 

Measurements in mm and kg. Deviations in sizes and weight (15 mm and 1,5 kg) are possible. Subject to technical alterations. Images for illustration purposes only. Certain features may be optional.

# D200 30°

## STANDARD MANUAL WHEELCHAIR WITH RECLINING BACKREST



**C86**  
carbon  
grey

- Available in 8 sizes (from 39 to 52 cm)
- Adjustable armrests in height and depth
  - Removable swing-away leg rests (in and outwards)
- reclinable backrest up to 30°
  - Push bar
- Padded seat and backrest
- Removable armrests

**D200 30° is a lightweight aluminum wheelchair with a 30° reclining backrest (adjustable without tools).**

A standard manual wheelchair perfect for a rental parc or personal use. D200 30° is a fully adaptable chair to suit any user or changes that are needed.



### Features



**Height adjustable**  
(3 different heights)



**Available with optional long armrests (B03)**



**Armrests adjustable in height and depth to suit specific needs**



### Technical information

■ Total width	580 / 600 / 620 / 640 / 660 / 680 / 700 / 720 mm
■ Total length	1010 mm
■ Total height	880 - 940 mm
■ Folded width	300 mm
■ Seat width	380 / 400 / 420 / 440 / 460 / 480 / 500 / 520 mm
■ Armrest height	220 - 240 mm

■ Seat height	470 - 530 mm
■ Backrest height	420 mm
■ Seat depth	430 mm
■ Weight	17,9 kg
■ Maximum user weight	130 kg
■ Additional information	CE

Measurements in mm and kg. Deviations in sizes and weight (15 mm and 1,5 kg) are possible. Subject to technical alterations. Images for illustration purposes only. Certain features may be optional.

# Eclips x4

MULTI ADJUSTABLE  
MANUAL WHEELCHAIR



- Adjustment of the seat depth
- Aluminum, height adjustable forks to keep the wheelchairs weight minimal
  - Foldable footplates
- Rear wheels with Quick-release system
- Backrest adjustable in height

**Eclips X4 is a VERMEIREN classic wheelchair that has proven its quality throughout history.** It is a light aluminum wheelchair with a multi-adjustable frame. The seat is adjustable in depth, has a reinforced cross for extra strength and Quick-release rear wheels that will provide a speedy disassembly when placing the wheelchair into a car.

The footrests can be folded both inward and outward and can be removed to limit the weight of the heaviest part.

## Features



*Extra long and padded armrests*



*Depth adjustable frame*



*Height adjustable frontwheels and aluminium forks*



*Tipping piece at the rear to overcome obstacles*



## Technical information

■ Total width	590 / 620 / 640 / 660 / 680 / 700 / 740 mm
■ Total length	1000 - 1210 mm
■ Total height	910 - 1015 mm
■ Folded width	300 mm
■ Seat width	390 / 420 / 440 / 460 / 480 / 500 / 550 mm
■ Armrest height	220 mm

■ Seat height	390 - 520 mm
■ Backrest height	420 - 460 mm
■ Seat depth	420 - 500 mm
■ Weight	17 kg
■ Maximum user weight	150 kg
■ Additional information	

Measurements in mm and kg. Deviations in sizes and weight (15 mm and 1,5 kg) are possible. Subject to technical alterations. Images for illustration purposes only. Certain features may be optional.

# Eclips x4 90°

MULTI ADJUSTABLE  
MANUAL WHEELCHAIR 90°  
RECLINABLE BACKREST



C29  
grey

- Height adjustable handles
- Inclination of the back by hydraulic springs for more comfort during the tilting
- Internal and external collapsible footplates
- Foldable and removable armrests
- Rear wheels with Quickrelease system

The knowledge and expertise we used to create the Eclips X4 lead to the birth of the Eclips X4 90°. Position changes throughout the day are beneficial for bloodflow, pressure relief or even just for comfort. With identical features to Eclips X4, Eclips X4 90° offers the additional option of fully reclining the backrest. Add the optional B14 backrest extension and the BZ7 legrests to create maximum comfort and space to lay down. The position of the rear wheel has been shifted to the back to keep the wheelchair in perfect balance and provide safety when the user is laying flat.



## Features



*Different adjustment possibilities for the seat height and seat depth*



*Removable pushbar for a better stability*



*Quick release wheels for rapid disassembly  
Tipping piece at the rear*



*Adjustment of the backrest by means of gas spring for a smooth adjustment*

## Technical information

■ Total width	590 / 620 / 640 / 660 / 680 / 700 / 740 mm
■ Total length	1000 - 1210 mm
■ Total height	910 - 1015 mm
■ Folded width	300 mm
■ Seat width	390 / 420 / 440 / 460 / 480 / 500 / 550 mm
■ Armrest height	235 mm

■ Seat height	390 - 520 mm
■ Backrest height	420 - 460 mm
■ Seat depth	420 - 500 mm
■ Weight	19,5 kg
■ Maximum user weight	130 kg
■ Additional information	CE

Measurements in mm and kg. Deviations in sizes and weight (15 mm and 1,5 kg) are possible. Subject to technical alterations. Images for illustration purposes only. Certain features may be optional.

# V300 30°

LIGHTWEIGHT ACTIVE  
WHEELCHAIR WITH  
RECLINABLE BACKREST

C59  
champagne

- Adjustable backrest up to 30°
- Adjustable armrest in depth
  - 5 seat angles
- A large number of available accessories
  - 4 seat heights
  - 5 seat depths
  - 3 armrests heights
  - 6 seat sizes available
- Storage bag under the seat



The V300 30° is a lightweight manual wheelchair for temporary or permanent use with many adjustment possibilities. Changing positioning during the day, the use or the evolution of the mobility of the user, has many advantages. The V300 30° gives you the option of reclining the backrest.



## Features



Reclinable backrest up to 30°



Seat and backrest  
tension adjustable



Adjustable seat depth



## Technical information

■ Total width	600 / 630 / 650 / 670 / 690 / 710 mm
■ Total length	1040 mm
■ Total height	850 - 940 mm
■ Folded width	310 mm
■ Seat width	390 / 420 / 440 / 460 / 480 / 500 mm
■ Armrest height	220 - 240 mm

■ Seat height	440 - 530 mm
■ Backrest height	420 mm
■ Seat depth	440 - 520 mm
■ Weight	18,3 kg
■ Maximum user weight	130 kg
■ Additional information	CE

Measurements in mm and kg. Deviations in sizes and weight (15 mm and 1,5 kg) are possible. Subject to technical alterations. Images for illustration purposes only. Certain features may be optional.

# V300

## LIGHTWEIGHT ACTIVE WHEELCHAIR



- Available in 9 different sizes (from 39 cm to 60 cm)
- 2 colour options (champagne and blue)
  - Tension adjustable backrest and seat
- Armrests adjustable in height and depth (3 x 2 adjustments)
  - Removable swing-away leg rests
- Removable armrests for easier transfers

The V300 is a lightweight manual wheelchair for temporary or permanent use with a fixed backrest. What makes the V300 unique is its seat depth of up to 52 cm. The largest seat depth in our range, providing maximum comfort to its user. The adaptable hook and loop backrest and seat cushion with comfortable padding are always included. **V300 also has other options available such as a headrest, table and side supports.**



### Features



Armrests adjustable in 3 different heights and 3 different depth settings



Backrest and seat are adjustable in tension



Adjustable seat depth



Numerous possibilities of adjustments and configurations

### Technical information

■ Total width	600 / 630 / 650 / 670 / 690 / 710 mm
■ Total length	1040 mm
■ Total height	850 - 940 mm
■ Folded width	310 mm
■ Seat width	390 / 420 / 440 / 460 / 480 / 500 mm
■ Armrest height	220 - 240 mm

■ Seat height	440 - 530 mm
■ Backrest height	420 mm
■ Seat depth	440 - 520 mm
■ Weight	17,7 kg
■ Maximum user weight	130 kg
■ Additional information	

Measurements in mm and kg. Deviations in sizes and weight (15 mm and 1,5 kg) are possible. Subject to technical alterations. Images for illustration purposes only. Certain features may be optional.



# V300 DL

LIGHTWEIGHT MANUAL  
WHEELCHAIR  
WITH MAXIMUM  
POSSIBILITIES

C59  
champagne

C80  
blue

- Push handles with textured anti-slip
- Adjustable in height push handles
- Tension adjustable backrest
- Removable metal pushbar
- Padded seat cushion with ant-slip bottom
- Anti-tipping wheels
- Angle adjustable footplates



V300 DL is a lightweight wheelchair from VERMEIREN. Completely customizable to its user. For example, the push handles and the armrests are adjustable in height. The footrests are removable and swing away. The wheels have black spokes and dark gray tires with a larger push button for easy removal of the rear wheels. Available with a comfortable seat and back cushions for maximum support.

## Features



Adjustable anti-tipping wheels



Push handles adjustable in height



Quick-release wheels for fast disassembly during transport



## Technical information

■ Total width	600 / 630 / 650 / 670 / 690 / 710 mm
■ Total length	1040 mm
■ Total height	890 - 990 mm
■ Folded width	320 mm
■ Seat width	390 / 420 / 440 / 460 / 480 / 500 mm
■ Armrest height	195 - 300 mm

■ Seat height	440 - 530 mm
■ Backrest height	460 mm
■ Seat depth	440 - 520 mm
■ Weight	18,8 kg
■ Maximum user weight	130 kg
■ Additional information	

Measurements in mm and kg. Deviations in sizes and weight (15 mm and 1,5 kg) are possible. Subject to technical alterations. Images for illustration purposes only. Certain features may be optional.

# V500 Light

LIGHTWEIGHT  
MANUAL  
WHEELCHAIR

**C80**  
blue



- Toolfree system
- In and outward folding of footrests
  - Foldable for easy storage
- Adjustable seat angle ( 0°-10°)
  - Modern look with blue frame
- Storage bag hidden under seat
- Large range of options available

Lighter than the V500, the V500 Light is our lightest standard wheelchair. Whether for temporary or permanent use, it improves the user's daily life and makes transport and transfers easier. As part of the V-series, the V500 Light offers a wide range of accessories and options to create and modify your V500 Light.

## Features



**Black front wheels**



**Adjustable seat height**



**Adjustable seat depth  
42 to 48 cm**



**Backrest and push handles adjustable in height**



**Seat angle adjustable (0-10°)**





**Adjustable armrests adjustable in height and depth**



## Technical information

■ Total width	590 - 620 - 640 - 660 - 680 - 700 mm
■ Total height	860 - 920 mm
■ Total length	975 - 1035 mm
■ Folded width	310 mm
■ Seat width	390 - 420 - 440 - 460 - 480 - 500 mm
■ Armrest height	150 - 210 mm

■ Seat height	470 - 530 mm
■ Backrest height	400 - 420 - 440 - 460 - 480 mm
■ Seat depth	420 - 480 mm
■ Weight	15,7 kg
■ Maximum user weight	130 kg
■ Additional information	 

Measurements in mm and kg. Deviations in sizes and weight (15 mm and 1,5 kg) are possible. Subject to technical alterations. Images for illustration purposes only. Certain features may be optional.

OPTIONS V500 - V500 30° Light



**Bi5** Armrest "Design"



**B66MAL** Guttet rotating armrest



**B06** Standard removable footrest



**BK6** One-piece footrest



**B19** Heel straps



**B21** Extra wide calf support



**BZ8** articulated legrest self-correcting in length



**BK7** Leg rest for amputee



**BP7** Plaster leg legrest



**B14** backrest extention



**B47** Standard adjustable headrest, for chairs with fabric backrest



**L55** Artificial leather headrest, adjustable for chairs with anatomical backrest



**B15A** Plastic table (black)



**B20** Safety belt with clip



**B58** Quick-release seat belt



**B22** Abduction block



**B31** Crutch holder



**B42** Transport net



**B78** Anti-tipping wheels



**B83** Oxygen cannister holder

■ Consult our order forms to discover all the possible options on [www.vermeiren.com](http://www.vermeiren.com) ■

# V500 Light 30°

LIGHTWEIGHT  
MANUAL  
WHEELCHAIR



**C80**  
blue

**C86**  
carbon  
grey

- Our lightest manual wheelchair
- Endless adjustment possibilities
  - Reclinable backrest
- Removable and swing-away leg rests

Just like the V500 Light is V500 Light 30° our lightest standard wheelchair with additional benefit of a **reclinable backrest**. Whether for temporary or permanent use, it improves the user's daily life and makes transport and transfers easier. As part of the V-series, the V500 Light 30° offers a wide range of accessories to modify your V500 Light and completely personalize it.



30° manual adjustment OR  
30° manual adjustment with gas springs

## Features



Ergonomic handles and pushbar



Removable armrests  
without additional tools



Folding brake levers  
for easy transfers



Removable leg rests with in and  
outwards wing-away function



## Technical information

■ Total width	590 - 620 - 640 - 660 - 680 - 700 mm
■ Total height	860 - 920 mm
■ Total length	975 - 1035 mm
■ Folded width	310 mm
■ Seat width	390 - 420 - 440 - 460 - 480 - 500 mm
■ Armrest height	150 - 210 mm

■ Seat height	470 - 530 mm
■ Backrest height	400 - 420 - 430 - 440 - 460 - 480 - 490 mm
■ Seat depth	420 - 480 mm
■ Weight	16,25 kg
■ Maximum user weight	130 kg
■ Additional information	CE

Measurements in mm and kg. Deviations in sizes and weight (15 mm and 1,5 kg) are possible. Subject to technical alterations. Images for illustration purposes only. Certain features may be optional.

## OPTIONS V500 - V500 30° Light



**B90**  
Push bar



**B91**  
Anti-theft bar



**B101** Anti-theft system  
with money-coin



**B52**  
Serum holder



**L04**  
Side supports



**L14 / L15** Anatomical  
seat / backrest  
in artificial leather



**L14 / L15** Soft Anatomical  
seta / backrest in  
soft artificial leather



**L34** Anatomical  
pre-shaped  
seat / backrest



**HEM2** set empilegico  
con doppio mancorrente



**B33** Push rims  
in gel 24"



**B24** Cushion 6 cm



**V16** Gel heel protectors  
(pair) 120 x 140 mm



**V20** Gel protection for  
a safety belt (2 parts)  
325 x 80 mm and 230 x 70 mm



**V24** Gel leg side protection  
(pair) - 310 x 90 mm



**V26** Gel strap support  
for legs 2 pieces  
400 x 190 mm



**V28** Gel plate footrest  
(pair) - 155 x 210 mm



**V30** Adhesive oval pad  
(pair) - 80 x 100 mm



**V32** Adhesive oval pad  
(pair) - 100 x 200 mm



**V36** Adhesive ovoid pad  
120 x 70 mm



**V38** Gel armrest pad  
(pair) - 90 x 300 mm

■ Consult our order forms to discover all the possible options on [www.vermeiren.com](http://www.vermeiren.com) ■

# Bobby

LIGHTWEIGHT FOLDABLE  
TRANSPORT WHEELCHAIR



**C80**  
blue

- Ergonomic armrests
- 2 individual brakes for parking
  - Brakes for carer
- Foldable footplates
- Adjustable foot belt support
  - Safety belt
- Foldable backrest

Transfer wheelchairs need to be light, easy to handle and foldable in mere seconds. With its removable footrests, foldable backrest and two pull straps to carry your Bobby with you during transport, it fits the description of a transfer wheelchair perfectly.

## Features



Foldable backrest



Tipping piece to easy overcome obstacles



Parking brakes



Optional side cover



## Technical information

■ Total width	575 - 635 mm
■ Total length	950 mm
■ Total height	940 mm
■ Folded width	270 mm
■ Seat width	420 - 480 mm
■ Armrest height	220 mm

■ Seat height	500 mm
■ Backrest height	380 mm
■ Seat depth	420 mm
■ Weight	12,2 kg
■ Maximum user weight	115 kg
■ Additional information	CE

Measurements in mm and kg. Deviations in sizes and weight (15 mm and 1,5 kg) are possible. Subject to technical alterations. Images for illustration purposes only. Certain features may be optional.

# Bobby EVO

LIGHTWEIGHT FOLDABLE  
TRANSPORT WHEELCHAIR



**C76**  
white

- Swing away armtubes
- 2 manual brakes
- Attendant brakes
- Padded armtubes
- Angle adjustable footplates
- Adjustable ankle straps

The Bobby EVO is your ideal compact, foldable transferchair. Light and easy to fold in seconds. Complete with padded, swing away armtubes and a foldable backrest making it easy to stow your chair away. Black front and rearwheels and removable and collapsible footrests.

## Features



Semi-foldable backrest



Length adjustable footrests



Push handles with locking parking brakes



Tipping pieces



Optional with B03 armrests (only in C80 blue)

## Technical information

■ Total width	490 - 550 mm
■ Total length	1010 mm
■ Total height	900 mm
■ Folded width	260 mm
■ Seat width	420 - 480 mm
■ Armrest height	200 mm

■ Seat height	490 mm
■ Backrest height	440 mm
■ Seat depth	420 mm
■ Weight	12,4 kg
■ Maximum user weight	115 kg
■ Additional information	CE

Measurements in mm and kg. Deviations in sizes and weight (15 mm and 1,5 kg) are possible. Subject to technical alterations. Images for illustration purposes only. Certain features may be optional.

# Physipro

POSTURE AND MOBILITY

The Physipro team specializes in the design, manufacturing and distribution of technical posture and mobility aids. Physipro has been able to meet the needs of its customers over the years by offering a range of highly customizable, state-of-the-art products.

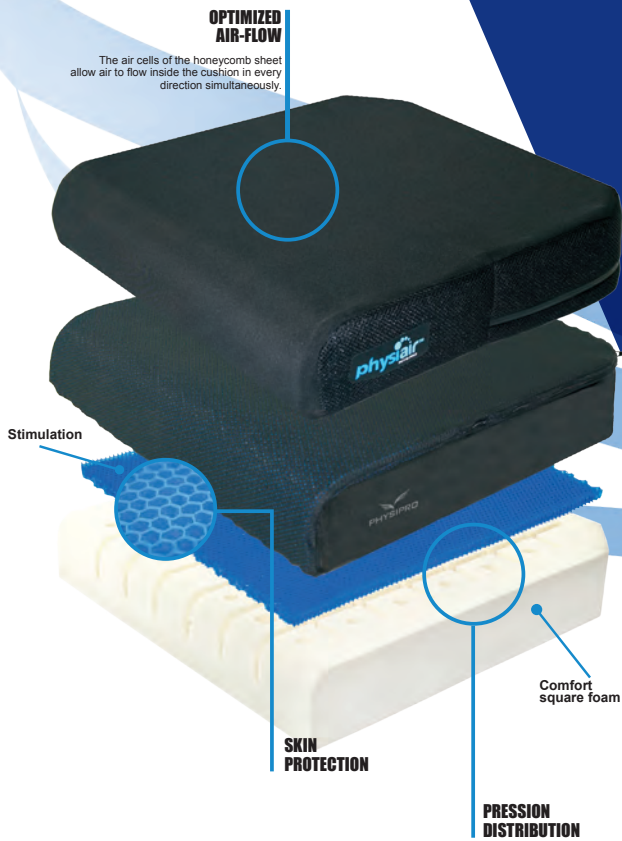

Images for illustration purposes only. Certain features may be optional.

## B66MAL

HEMIPLEGIC ARMREST

Our hemiplegic armrests offer a wide range of solutions for your needs.

Our range includes comfort solutions adapted to your individual situation



B66MAL - Right side



B66M



B66MA - Left side



B66MA - Right side



B66MAL - Left side



B66ML





# Stabilo

## COMFORT ARMREST

blue

**Hemiplegic armrest with vacuum technology, allowing the armrest to be reshaped endlessly.**

Ideal for patients with differently shaped joints, the armrest adjusts to individual needs and situations of hand and forearm with room for evolvments.

**Medium:** 25 x 30 x 4 cm

**Large:** 25 x 45 x 7cm

Measurements in mm and kg. Deviations in sizes and weight (15 mm and 1,5 kg) are possible. Subject to technical alterations. Images for illustration purposes only. Certain features may be optional.

# V-Drive



Easy to use controller



Adjustable in height to keep the motor horizontal

## ELECTRICALLY-POWERED PUSH SUPPORT FOR MANUAL WHEELCHAIRS

**Powered push assistance for your manual wheelchair.**

V-drive is an easy-to-use assistant for the carer to help them overcome uneven ground or to climb slopes. The push assistant provides support when needed.

**Version standard** - Maximum user weight 135 kg - (wheelchair included)

**Version H.D.** - Maximum user weight 200 kg - (wheelchair included)

### Technical information

■ Seat width	390 - 480 mm (500 - 600 mm H.D. version)
■ Total length	450 mm
■ Total height	390 mm
■ Speed	6 km/h
■ Maximum inclination	+6° (10%)
■ Driving range	16 km

■ Batteries	150 W (200 W version H.D.)
■	2 x 12 V / 12 Ah
■ Weight	19 kg (version 23 kg H.D.)
■ Maximum user weight	135 kg* (200 kg* version H.D.)
■	* wheelchair included
■ Additional information	CE

Measurements in mm and kg. Deviations in sizes and weight (15 mm and 1,5 kg) are possible. Subject to technical alterations. Images for illustration purposes only. Certain features may be optional.

# Gel Pads

In some cases a little additional protection to support certain body parts is needed to provide the best and ultimate comfort when using a manual wheelchair.

**VERMEIREN** offers a range of comfort gel cushions that are easy to install and can be used in nearly all situations.



**V10** protective cover  
60 x 240 mm (pair)



**V12 - V14** Protective gel covers for tubing 6'' - 8'' (pair)  
120 x 160 mm - 120 x 200 mm



**V16** Gel heel protectors (pair) 120 x 140 mm



**V18** Gel pad with self fastener for walker or crutch (pair) 120 x 130 mm



**V20** Gel protection for a safety belt (2 parts) 325 x 80 mm and 230 x 70 mm



**V22** Gel protection for gutted armrest (pair) 110 x 340 mm



**V24** Gel leg side protection (pair) - 310 x 90 mm



**V26** Gel strap support for legs 2 pieces 400 x 190 mm



**V28** Gel plate footrest (pair) - 155 x 210 mm



**V30** Adhesive oval pad (pair) - 80 x 100 mm



**V32** Adhesive oval pad (pair) - 100 x 200 mm



**V34** Adhesive oval pad (pair) - 120 x 300 mm



**V36** Adhesive ovoid pad 120 x 70 mm



**V38** Gel armrest pad (pair) - 90 x 300 mm



**V40** Gel protective knee pad (pair) - 100 x 100 mm

# Blumil

CONNECT & EXPLORE

The Blumil add-ons have one incredibly unique feature - a patented connecting system. There is no need to attach any additional parts to your own wheelchair. You just press a button and the electric system does the rest for you. 5 seconds later you are ready to GO with absolutely no assistance from anyone. You can be fully independent, no matter how much strength you have in your hands.



SCAN this QR code and discover the Blumil catalogue.



B L U M I L



SCAN this QR code and discover the Blumil movie.



03 | POWERED WHEELCHAIRS



## ADULT POWERED WHEELCHAIRS

Verso	54
Plego	59
Forest 3	60
Sigma	64
Turios	70
Navix	71
Timix	72
Timix SU	73
Forest 3 SU	75
Navix SU	76
Express	77

### Searching for a powered wheelchair for indoor, outdoor or compact use?

**VERMEIREN** has a wide range of powered wheelchairs that will meet the needs of their users. Each powered wheelchair is made to order and can be equipped with dozens of options or accessories. Not enough? On top of that our team can also offer a special manufactured version totally adapted to the user of the chair.

# Verso



Verso \ LIGHTWEIGHT ADAPTABLE POWERED WHEELCHAIR

# Verso

## EASY TO USE

Simple, yet perfect. Verso has it all. Disassemble your wheelchair in a few seconds. All parts are easy to carry and not too heavy for easy transport in a car. Assembly is easy with our Click&Drive system.

No tools needed, just connect your battery and you're ready to drive! Thanks to our removable battery, you can charge your chair whenever and wherever you like.



## BATTERY & MOTORS

The battery (available in 12,8 Ah or 17,5 Ah) is conveniently located at the back of your wheelchair for easy access when you need to remove it for charging or to quickly check your battery status. Easily unlock your battery with your own anti-theft key to charge it anywhere you like. With 2 x 200W motors and 12"PU black tires, Verso is competing with others in its category. A great and durable choice for a powered wheelchair for everyday use.

## EASY TO TRAVEL

A unique feature for Verso is the detachable motor and battery block. Detach your wheelchair from its battery and wheel block to allow for easy storage and transport. Both the frame and the "powered part" of Verso have an additional wheel to make sure no parts can be damaged by detaching. They also allow for easy manoeuvring. The seat can easily be folded like you would any of our other top-selling manual wheelchairs. Perfect for transport in the boot of the car or storage in your home.



# Verso

## LIGHTWEIGHT ADAPTABLE POWERED WHEELCHAIR



Colours are a personal experience, just like your Verso. Choose the colour combination that suits your style the best. Select your frame colour between glossy white and glossy black and play with colour accents to make it your style.

SCAN the QR code  
and enjoy the Verso movie.



**Verso is versatile and agile powered wheelchair. Its lightweight design makes it a perfect wheelchair for users on the move who would like to extend their mobility without compromising on comfort.**

Thanks to our extensive expertise in options, Verso offers its user a remarkable adaptability to its user. Crafted by merging the durability of a manual wheelchair frame with the advanced features of two motorized rear wheels, Verso

is a perfect choice for a comfortable, lightweight powered wheelchair. The lithium battery can be removed for easy charging to enhance convenience in your daily use.

With a sleek design and fun colour accents, Verso can be adapted to your preferences whilst having a modern and attractive look. The colour accents serve a double purpose as they allow you to easily locate the levers of the powered part.

### Features



Highly configurable with a variety of options.



Removable motor unit from the seating frame. Removable lithium battery equipped with safety lock.



**Two in one. Convert your Verso into a MANUAL WHEELCHAIR.** Verso offers a quite unique option for people who are in need of both a manual and powered wheelchair. With our 24" wheel kit you can easily change between manual or powered driving. Plug and drive!

### Technical information

■ Total width	598 mm
■ Total length	1078 mm
■ Seat height	521 mm
■ Seat width	390 - 420 - 440 - 460 - 480 - 500 mm
■ Seat depth	420 - 480 mm
■ Batteries	12,8 Ah - 24 V or 17,5 Ah - 24 V

■ Motors	2 x 200 W
■ Speed*	6 km/h
■ Driving range	15 km or 21 km
■ Weight	31,3 kg
■ Maximum user weight	130 kg
■ Additional information	CE

\* The driving range is calculated according to European standards. \* Speed and driving range may deviate (ca. 15%). Permitted dimensional and weight tolerances: 15 mm, 1.5 kg and 1.5°. Subject to technical alterations. Images for illustration purposes only. Certain features may be optional.

# OPTIONS Verso



**B66MAL** Guttet rotating armrest



**L04TL** Side support Small or large



**SE08** Backrest controller fixation



**SE53** Swing-away controller



**L14** Fixed anatomic backrest (soft)



**L15** Fixed anatomic seat (soft)



**L34** Pre-shaped backrest (soft)



**L35** Pre-shaped seat (soft)



**B02** Removable and folding long armrest



**B03** Removable and folding armrest



**B04DL** Removable height adjustable long armrest



**L58C** Comfort headrest adjustable in width and angle



**BK6** One-piece footrest



**BZ8** articulated legrest self-correcting in length



**Extra battery** 17,5 AH - 24V



**Air tyres** Front / Rear air tyres



**SE19** Front and rear light set

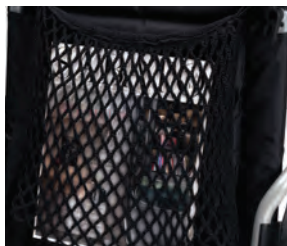

**B42** Shopping net



**30°** Backrest inclination



**SE44** Kit 24" wheels black PU

■ Consult our order forms to discover all the possible options on [www.vermeiren.com](http://www.vermeiren.com) ■



In just a few steps, Plego transforms into a compact and easy to store wheelchair. The complete tool free system can be folded by a single person without any strain or without the hassle of removing the battery.

**Ready for a day out?** Check your battery status easily whilst seated thanks to our battery status indicator located underneath your seat. The Lithium-ion battery can be locked safely with an anti-theft key or charged separately from your chair. No need to bring your entire chair closer to the outlet. Just take your battery and charge it wherever is most convenient. It is important to note that Plego is approved for air transport according to IATA standards.\*

To ease your mind about the driving range or your battery charge, extend your battery life with an additional battery (12,8Ah or 17,5Ah) that can easily be stored underneath your seat with the additional storage bag.



SCAN the QR code  
and enjoy the Plego movie.

\*Please consult our manual for the latest information.

# Plego

FOLDABLE LIGHTWEIGHT  
POWERED WHEELCHAIR



Powered wheelchairs can sometimes be hard to store due to their bulky size or their large total mass, especially when you're travelling. Introducing Plego, a foldable lightweight powered wheelchair that can be folded easily. Even when folded, the wheelchair stays upright and can be manoeuvred not unlike a suitcase.

Whether you are just out and about for a short trip to the shops or exploring a city, Plego can be easily used to explore whilst extending your mobility. The 2 x 250W brushless geared motors are not only quiet and powerful when driving, they are very low maintenance and durable in use. In need of a little extra urban comfort? Plego has a variety of options such as extra storage or lights.

Built upon 65+ years of Belgian expertise and entirely crafted in Europe, this powered wheelchair embodies our commitment to the utmost standards of quality, safety, and comfort. Discover more about Plego's features and benefits to boost your life!

With a maximum speed of 6 km/h, Plego is a perfect choice to go on adventures with your friends and family. It has a comfortable driving speed to keep up whilst having a conversation comfortably during a walk. The lightweight Lithium-ion battery gives you a driving range of up to 21 km\*. Perfect for a day out!



## Features



Document pouch  
at the back



Userfriendly  
controller

## Technical information

Total width	595 mm
Total length	1000 mm
Seat height	530 mm
Seat width	450 mm
Seat depth	430 mm
Batteries	12,8 Ah - 24 V or 17,5 Ah - 24 V

Motors	2 x 250 W
Speed*	6 km/h
Driving range*	15 km or 21 km
Weight	24,5 kg
Maximum user weight	130 kg
Additional information	CE

\* The driving range is calculated according to European standards. \* Speed and driving range may deviate (ca. 15%). Permitted dimensional and weight tolerances: 15 mm, 1,5 kg and 1.5%. Subject to technical alterations. Images for illustration purposes only. Certain features may be optional.



Forest 3

POWERED WHEELCHAIR

# Forest 3

## DRIVING SAFELY AND COMFORTABLY

Known for its innovative front axle system, the Forest 3 allows its user to drive safely and comfortably on various surfaces. With Forest 3, you'll overcome obstacles with ease in your daily life. A wheelchair made for adventures both indoors and out.



## COMPACT FOR EASY MANEUVERING

The small and compact size of Forest 3 gives you a smooth turning radius. Perfect for indoor use or in social situations. Navigate small and narrow spaces or corridors easily with its small frame.

## POWERED WHEELCHAIR WITH ENDLESS POSSIBILITIES

With more than 20 colour options, a large number of options, and adjustments.... Forest 3 can be personalised to any driver and their preferences. Although every Forest is different, the quality and durability remain constant. Every user has unique needs and the Forest 3 can easily adapt to meet yours.



# Forest 3

ADULT POWERED  
WHEELCHAIR



We offer more than 32 different colours. For more information, please check our website.



SCAN the QR code and enjoy the Forest 3 movie.

Compact, durable, and high-performing, the Forest 3 is the ideal choice for those seeking a versatile powered wheelchair for both indoor and outdoor use. Designed with over 55 years of expertise, it seamlessly combines strength, comfort, and adaptability.

The front-wheel axle is a key feature, ensuring all four wheels maintain constant contact with the ground while providing stability and a smooth ride. For added control, the optional

V-Stab technology helps the user stay on course over rough terrain or obstacles without the need for constant steering adjustments.

Comfort is essential for everyday use, and the Forest 3 delivers with its pre-shaped backrest and customisable options, offering a tailored experience to meet individual needs.

## Features



Electric-powered inclination of the backrest and seat



Rotating axle to allow constant ground contact on all the wheels



Adjustable and foldable armrests with memory position

## Technical information

Total width	595 / 610 / 630 / 650 mm
Total length	1185 / 1205 / 1224 mm
Total height	1036 mm
Seat height	430 - 480 mm
Seat width	400 / 420 / 450 / 480 / 500 mm
Seat depth	420 - 520 mm

Batteries	2 x 12V / 80Ah - 220W or 350W
Speed*	6 km/h or 10 km/h
Driving range*	42 or 50 km
Weight	139 kg
Maximum user weight	130 kg
Additional information	

\* The driving range is calculated according to European standards. \* Speed and driving range may deviate (ca. 15%). Permitted dimensional and weight tolerances: 15 mm, 1.5 kg and 1.5°. Subject to technical alterations. Images for illustration purposes only. Certain features may be optional.

# OPTIONS Forest 3



**B66MAL** Guttet rotating armrest



**Armrest** preshaped PU



**Armrest** artificial leather upholstery

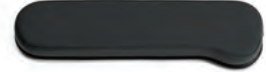

**Armrest** soft upholstery



**B06** Removable and swing away footrests



**BZ8 ART** Articulating comfort legrests



**BZE** Powered articulating comfort legrests



**L34** Pre-shaped backrest (soft)



**L35** Pre-shaped seat (soft)



**L16 + L35** Removable seat cushion with fasteners + board



**TUB + L34** Tubular pre-shaped backrest with adjustable aluminium clamps



**TUB + L44** Tubular backrest with adjustable tension



**SE53** Swing away controller



**S53A** Swing away controller with lock positions



**S53Z** Drop swing away controller for easy table access



**SE02** Controller integrated in the table



**LINX LCD** Electronic display



**SE04** Chin controller



**SE08** Mounting bracket for using main joystick as attendant control



**SE09** Dual joystick for attendant control



Sigma

POWERED WHEELCHAIR

# Sigma

## UNIQUE TRIPLE AXLE SYSTEM

The SIGMA is equipped with a triple axel system (1 on each side + 1 at the rear). This allows it to absorb all the irregularities of the ground and to remain perfectly stable, even for crossings up to 65 mm (depending on configuration). We have decided to call this unique technology "All-Tracks".



## ULTRA-COMPACT, PERFECT FOR INDOOR USE

Thanks to its six wheels and its small compact size, Sigma has a small turning radius. The wheelchair turns easily without losing its compactness or using up too much space. Sigma is an excellent choice for indoor use in compact and narrow environments.

## PERSONALISED TO YOU AND YOUR LIFESTYLE

With a large range of options, accessories, personalized adjustments and colours, Sigma is a fully personal powered wheelchair made to suit you and your lifestyle. Mix and match to find the perfect combination suitable for your daily activities, style choices or needs. Sigma is a personalized chair, with an evolving approach.





# Sigma

ADULT POWERED WHEELCHAIR WITH SIX WHEELS

**C55**  
metal grey

**C79**  
pacific blue

**C89**  
copper



We offer more than **32** different colours.

For more information, please check our website.



SCAN the QR code and enjoy the Sigma movie.

## Features



One of the most compact chairs in its league (1130mm length with leg rests)



Battery disconnection button, ideal for transport or storage



Available in SIGMA 230 for an obstacle clearance of up to 65 mm

## Technical information

■ Total width	618 / 630 / 660 / 680 mm
■ Total length	1177 mm
■ Total height	1055 - 1400 mm
■ Seat height	435 - 778 mm
■ Seat width	400 / 420 / 450 / 480 / 500 mm
■ Seat depth	420 / 440 / 460 / 480 / 500 / 520 mm

■ Batteries	2 x 12V / 80Ah - 220W or 350W
■ Speed*	6 km/h or 10 km/h
■ Driving range*	35 km
■ Weight	141 kg
■ Maximum user weight	140 kg
■ Additional information	

\* The driving range is calculated according to European standards. \* Speed and driving range may deviate (ca. 15%). Permitted dimensional and weight tolerances: 15 mm, 1.5 kg and 1.5°. Subject to technical alterations. Images for illustration purposes only. Certain features may be optional.

# OPTIONS Sigma



**B66MAL** Guttet rotating armrest



**Armrest** preshaped PU



**Armrest** artificial leather upholstery



**Armrest** soft upholstery



**B06** Removable and swing away footrests



**BZ8 ART** Articulating comfort legrests



**BZE** Electrical articulating comfort legrests



**L34** Pre-shaped backrest (soft)



**L35** Pre-shaped seat (soft)



**L16 + L35** Removable seat cushion with fasteners + board



**TUB + L34** - Tubular pre-shaped backrest with adjustable aluminium clamps



**TUB + L44** Tubular backrest with adjustable tension



**SE53** Swing away controller



**S53A** - Swing away controller with lock positions



**S53Z** Swing away down controller for easy table access



**SE02** Controller integrated in the table



**LINX LCD** Electronic display



**SE04** Chin controller



**SE08** Controller at the back



**SE09** - Dual control accompanying person



**SE42+SE39 - Optional LIFT**  
with 45° seat tilt



# OPTIONS Sigma



**SE64**  
Separate controller



**SE37**  
Side supports (soft)



**SE82**  
Button controller



**SE83**  
Mini-Joystick



**SE01**  
Mudguards on the rear wheels



**SE16**  
Transparent plastic clothing protectors



**SE19**  
LED lighting set



**SE24**  
Cup holder



**SE26**  
Push bar



**SE74A**  
Adjustable rear view mirror



**B15**  
Transparent plastic table



**B31**  
Crutch holder



**SE28**  
Luggage rack



**L04**  
Side supports



**L58** Adjustable pre-shaped headrest



**L58C** Comfort headrest adjustable in width and angle



**SE55**  
Reinforced controller



**692** Pair of foldable ramps

# Turios

## COMPACT POWERED WHEELCHAIR



The batteries of the Turios can be transported by plane.

SCAN the QR code and enjoy the Turios movie.

**Turios is the most compact powered wheelchair in our range. The modern-looking chair is entirely adjustable to your preferences and needs. With a large range of colors and options available, you can configure and create a Turios completely suited to you.**

Thanks to its small size, Turios maneuvers easily when used in indoor or narrow spaces. Public transport, using an elevator, or moving around in the comfort of your own

home, this powered wheelchair conquers it all. Driving outdoors also poses no issue. Adapted to conquer larger obstacles with its large rear wheels, it remains stable even when driving over thresholds.

Adapt your positioning all day long or throughout your use to relieve pressure points or to find the most comfortable position for you. The electric-powered backrest allows for easy changes with minor effort and are included in all versions of Turios.

### Features



Foldable manual backrest



Taxi hooks for safe transport



Optional SE19 LED lights and indicators



BZ8E - Electrical adjustable comfort legrests (optional)

### Technical information

Total width	580 / 610 / 640 mm
Total length	1060 - 1070 mm
Backrest height	550 mm
Seat height	490 - 520 mm
Seat width	390 / 420 / 450 / 480 / 510 mm
Seat depth	430 - 510 mm

Batteries	2x12V/38Ah/150W or 2x12V/50Ah/450W
Speed*	6 km/h or 10 km/h
Driving range*	>25 km
Weight	105,8 kg
Maximum user weight	130 kg
Additional information	

\* The driving range is calculated according to European standards. \* Speed and driving range may deviate (ca. 15%). Permitted dimensional and weight tolerances: 15 mm, 1.5 kg and 1.5°. Subject to technical alterations. Images for illustration purposes only. Certain features may be optional.

# Navix

## COMPACT POWERED WHEELCHAIR



- Higher ground clearance
- Overcome obstacles easily
- Easy transfers
- Compact: easy to transport
- Adjustable to individual needs
- Practical when driving: visualization of its total width

Navix climbs minor obstacles such as thresholds indoors with ease. Perfect for use in larger indoor areas such as shopping malls or event spaces.

Adjust your Navix to your individual needs. Additionally, transfers to a bed, bath, toilet, or chair are significantly easier thanks to its simple yet durable frame. Extend your autonomy by transporting your chair even in smaller cars.

*Also available as a rear wheel drive*



### Features



*Electric-powered reclinable seat and backrest and a tension adjustable backrest*



*Large front wheels for optimal maneuverability, especially in tight spaces*



*Optional lift function*



*Easy to disassemble for transport*

### Technical information

■ Total width	580 / 630 mm
■ Total length	1058 mm
■ Total height	956 mm
■ Seat height	400 / 450 / 500 mm
■ Seat width	400 / 450 / 500 mm
■ Seat depth	380 - 500 mm

■ Batteries	2x12V/38Ah/50Ah/220W
■ Speed*	6 km/h
■ Driving range*	20 km
■ Weight	78,8 kg
■ Maximum user weight	130 kg
■ Additional information	CE

\* The driving range is calculated according to European standards. \* Speed and driving range may deviate (ca. 15%). Permitted dimensional and weight tolerances: 15 mm, 1.5 kg and 1.5". Subject to technical alterations. Images for illustration purposes only. Certain features may be optional.

# Timix

## POWERED WHEELCHAIR



We offer more than 32 different colours. For more information, please check our website.

- Stability axle ensuring contact of all four wheels with the ground on uneven terrains up to 90 mm
- Full suspension on all wheels
- Fully integrated motor release levers
- Adjustable seat depth
- In- and outwards swing-away controller

Timix offers the best of both worlds: a tight turning radius for easy maneuvering indoors and a top performance with a speed of up to 14km/h. Driving in- and outdoors is a pleasure.

The comfort of Timix is very high. Four-wheel drive suspension. Regardless of the unevenness of the terrain, the wheels remain in constant contact with the ground.



### Features



Rotating axle to allow constant ground contact



Adjustable and foldable armrests with memory position



Optional lift system

### Technical information

■ Total width	640 - 660 mm
■ Total length	1270 - 1292 - 1315 mm
■ Total height	1065 mm
■ Seat height	490 - 540 mm
■ Seat width	400 - 450 - 500 mm
■ Seat depth	420 - 520 mm

■ Batteries	2x12V/80Ah/220W or 2x12V/80Ah350W
■ Speed*	6 km/h, 10 km/h or 14 km/h
■ Driving range*	40 - 63 km
■ Weight	125 kg
■ Maximum user weight	130 kg
■ Additional information	

\* The driving range is calculated according to European standards. \* Speed and driving range may deviate (ca. 15%). Permitted dimensional and weight tolerances: 15 mm, 1.5 kg and 1.5°. Subject to technical alterations. Images for illustration purposes only. Certain features may be optional.

# Timix su

STAND-UP  
POWERED WHEELCHAIR



We offer more than 32 different colours. For more information, please check our website.

- V-Stab trajectory control system included
- Rotating axle at the rear for optimal driving
- Width, height and depth adjustable armrests with memory position
- Lighting included

The TIMIX SU is a front-wheel drive-powered wheelchair. It has an SU (Stand-up) verticalization function.

It is as comfortable indoors, including in small spaces, as it is outdoors thanks to its crossing capacity. Like the TIMIX, with large front drive wheels for easy turning even in tight spaces and available in 6 km/h, 10 km/h or 14 km/h versions.

## Features



With its large front wheel drive, the Timix SU is ideal for outdoor use



3 possible positions:  
vertical, seated or horizontal



Very comfortable with padded seat and backrest

## Technical information

■ Total width	635 / 670 mm
■ Total length	1260 mm
■ Total height	1120 mm
■ Seat height	540 mm
■ Seat width	400 / 450 mm
■ Seat depth	420 / 470 mm

■ Batteries	2x12V/80Ah/220W or 2x12V/80Ah350W
■ Speed*	6 km/h, 10 km/h or 14 km/h
■ Driving range*	40 - 63 km
■ Weight	160,3 kg
■ Maximum user weight	130 kg
■ Additional information	CE

\* The driving range is calculated according to European standards. \* Speed and driving range may deviate (ca. 15%). Permitted dimensional and weight tolerances: 15 mm, 1.5 kg and 1.5°.  
Subject to technical alterations. Images for illustration purposes only. Certain features may be optional.



# Forest 3 su

STAND-UP  
POWERED WHEELCHAIR



We offer more than 32 different colours. For more information, please check our website.

- Stability axle ensuring contact of all four wheels with the ground on uneven terrains up to 90 mm
- Full suspension on all wheels
- Fully integrated motor release levers
- Adjustable seat depth
- In- and outwards swing-away controller

The Forest 3 SU is a power wheelchair with a stand-up possibility. Just like its brother, the Forest 3 but with additional functions.

Complete with a safety belt at chest level and a padded knee guard for complete comfort and safety. The control unit allows the user to shift from the standing position to the sitting position to the 180° reclined position. The small wheels on the front footplate provide additional stability when driving your Forest 3 SU.



3 possible positions: vertical, seated or horizontal



L04 Optional side supports



Adjustable backrest

## Technical information

■ Total width	602 - 670 mm
■ Total length	1170 mm
■ Total height	1100 - 1575 mm
■ Seat height	530 mm
■ Seat width	400 - 450 mm
■ Seat depth	420 - 470 mm

■ Batteries	2x12V/80Ah/220W
■ Speed*	6 km/h
■ Driving range*	50 km
■ Weight	165 kg
■ Maximum user weight	130 kg
■ Additional information	CE

\* The driving range is calculated according to European standards. \* Speed and driving range may deviate (ca. 15%). Permitted dimensional and weight tolerances: 15 mm, 1.5 kg and 1.5°.  
Subject to technical alterations. Images for illustration purposes only. Certain features may be optional.

# Navix su

STAND-UP  
POWERED WHEELCHAIR



We offer more than 32 different colours. For more information, please check our website.



- Reclinable up to 180°
- Trunk support belt
- Powered leg rests with automatic length compensation



The Navix SU also known as Navix Stand-Up is a powered standing chair with most of the features of a Navix and the addition of the standup function.



Additional support with castors for standing function

## Features



Knee protection pads



3 possible positions: vertical, seated or horizontal

## Technical information

■ Total width	602 - 670 mm
■ Total length	1090 mm
■ Total height	1040 - 1570 mm
■ Seat height	470 mm
■ Seat width	400 - 450 mm
■ Seat depth	395 - 470 mm

■ Batteries	2x12V/38Ah/220W or 2x12V/50Ah220W
■ Speed*	6 km/h
■ Driving range*	20 - 32 km
■ Weight	122 kg
■ Maximum user weight	130 kg
■ Additional information	CE

\* The driving range is calculated according to European standards. \* Speed and driving range may deviate (ca. 15%). Permitted dimensional and weight tolerances: 15 mm, 1.5 kg and 1.5°. Subject to technical alterations. Images for illustration purposes only. Certain features may be optional.

# Express

COMPACT  
POWERED WHEELCHAIR



C29  
grey

**Installed with the LE controller system which is:**

- Ideal for lightweight, indoor wheelchairs
- Easy to use
  - Simple
  - Reliable

The Express is an powered wheelchair with a double cross, equipped with footrests and armrests which are adjustable in height and width.

Complete with a powerful motor and batteries for a smooth driving experience. The Express is very compact making it easy to navigate in smaller spaces and can also be folded to facilitate transport.



## Features



**Separate batteries, easy to remove and carry**

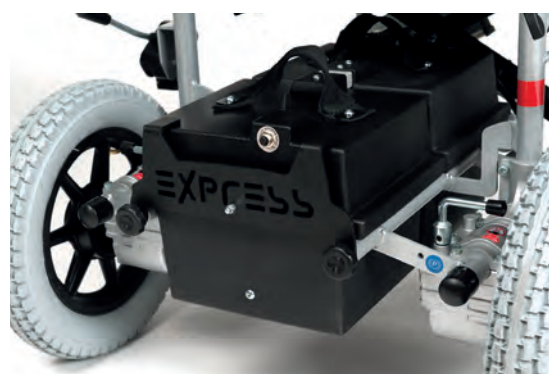



**Compact and functional design**



**Foldable for limiting space during transport**

## Technical information

■ Total width	580 / 610 / 630 / 650 / 690 mm
■ Total length	950 mm
■ Total height	960 mm
■ Seat height	540 mm
■ Seat width	390 / 420 / 440 / 460 / 500 mm
■ Seat depth	430 mm

■ Batteries	2x12V/38Ah/150W or 2x12V/50Ah150W
■ Speed*	6 km/h
■ Driving range*	18 - 25 km
■ Weight	67 kg
■ Maximum user weight	90 kg
■ Additional information	 

\* The driving range is calculated according to European standards. \* Speed and driving range may deviate (ca. 15%). Permitted dimensional and weight tolerances: 15 mm, 1.5 kg and 1.5°.  
Subject to technical alterations. Images for illustration purposes only. Certain features may be optional.





## KIDS WHEELCHAIRS

Trigo kids	80
Sagitta kids	81
Eclips X2	82
Eclips X2 30°	83
Jazz S50 Kids	84
Bayo	85
Inovys Junior	86
Gemini 2	88
Forest kids	90
Springer	91

**Our mobility can challenge us, even from a young age. At VERMEIREN we try to make sure that you can overcome these challenges together, no matter short- or long-term.**

**VERMEIREN** offers a wide range of products for children and young adults to ensure the best mobility solution. From care wheelchairs to flashy active wheelchairs, our products offer something for everyone.



# Trigo KIDS

MANUAL ACTIVE LIGHT  
KIDS WHEELCHAIR



We offer more than 32 different colours. For more information, please check our website.



SCAN the QR code and watch the Trigo movie.

**Trigo Kids is the mirror image of its adult counterparts. The bright and colourful design with many options allow you to design a style completely suited to your own personal taste.**

Trigo is designed to be lightweight and foldable, so that transporting is easy. Trigo kids is a trendy wheelchair to suit children with an active and mobile lifestyle, whilst remaining comfortable throughout the day and use. The

sporty designed rearwheels with black rims, easy accessible brakes and small front wheels ensure a small turning radius. The wheelchair's centre of gravity can be adjusted to suit each users' needs. Depending on the setting, the weight distribution can be moved forward or backwards.

**Trigo Kids is available in 2 versions:** Trigo Kids S and Trigo Kids T. Trigo S has a fixed and height adjustable footrest while Trigo T has removable and height adjustable footrests.

## Features



Front wheels with LED lights (optional)



Legrests BZ8 (optional) for ultimate comfort



B85 - Wide range of optional spoke protectors

## Technical information

Total width	460 - 660 mm
Total length	676 - 1046 mm
Total height	457 - 945 mm
Distance footplate and seat	220 - 500 mm
Seat width	240 - 340 mm
Seat inclination	20°

Seat height	380 - 510 mm
Backrest height	250 - 500 mm
Seat depth	320 - 500 mm
Weight	>11 kg
Maximum user weight	70 - 130 kg
Additional information	CE

Measurements in mm and kg. Deviations in sizes and weight (15 mm and 1,5 kg) are possible. Subject to technical alterations. Images for illustration purposes only. Certain features may be optional.

# Sagitta KIDS

MANUAL ACTIVE LIGHT  
KIDS WHEELCHAIR



We offer more than 32 different colours. For more information, please check our website.



SCAN the QR code and discover the Sagitta kids.

Based on our successful Sagita model, Sagitta Kids is the children's equivalent of our adult version. Sagitta is a modern active manual wheelchair with endless personalization options. The armrests and leg rest are fully adjustable as well as a varied number of its measurements. A fully customizable wheelchair, fit-to-size, for its user. Sagitta is available in a wide variety of colors, with colorful spoke protectors and wheel choices.



## Features



Tension adjustable backrest



Foldable backrest for easy transport

Made-to-measure wheelchair thanks to its many adjustable features

## Technical information

Total width	460 - 655 mm
Total length	700 - 750 mm
Height with folded backrest	440 mm
Turning radius	758 - 917 mm
Seat width	300 / 500 mm
Seat angle	-7° / +7°

Seat height	370 - 428 mm
Backrest height	230 - 430 mm
Seat depth	280 - 300 - 320 mm
Weight	9 kg
Maximum user weight	60 kg
Additional information	CE

Measurements in mm and kg. Deviations in sizes and weight (15 mm and 1,5 kg) are possible. Subject to technical alterations. Images for illustration purposes only. Certain features may be optional.

# Eclips x2

LIGHTWEIGHT ALUMINIUM  
MANUAL KIDS WHEELCHAIR



- Easy to transport due to its weight of 8,1 kg
- Quick-release wheel removal
- Included clothes protectors
- Height adjustable push handles
- Upholstered canvas seat

**Compact and multifunctional, the Eclips X2 Kids has all the essential features to adapt to the needs of its user.**

Fully collapsible for easy transport, swing-away footrests, adjustable push handles,... all in a trendy and eye-catching red colour. This manual wheelchair is equipped with brakes and folding backrest. Available in seat width available.

## Features



*Foldable backrest*



*Ultra compact*



*BZ7 - Optional comfort legrest*

## Technical information

■ Total width	520 mm
■ Total height	930 mm
■ Total length	830 mm
■ Folded width	320 mm
■ Seat width	320 - 360 mm
■ Armrest height	190 mm

■ Seat height	440 mm
■ Backrest height	330 mm
■ Seat depth	320 mm
■ Weight	13,6 kg
■ Maximum user weight	60 kg
■ Additional information	CE

Measurements in mm and kg. Deviations in sizes and weight (15 mm and 1,5 kg) are possible. Subject to technical alterations. Images for illustration purposes only. Certain features may be optional.



# Eclips x2 30°

MANUAL KIDS WHEELCHAIR WITH RECLINABLE BACKREST

C4  
red

- Manually adjustable backrest up to 30°
- Aluminium front wheel forks
- Easy transport, even in smaller cars
- Easy to maintain upholstery
- Ergonomic push handles and a pushbar for increased stability of the wheelchair

The ideal wheelchair for children, ideal to withstand lots of playing with its robust frame. Remove the wheels, fold the backrest, remove the footrest and you have a perfect compact transportable wheelchair. Eclips X2 30° is comfortable, even when used for longer periods of time.



Foldable backrest for easy storage or transport in a car



30° adjustable backrest



B85 Optional wheel protectors

## Technical information

■ Total width	520 mm
■ Total height	885 mm
■ Total length	960 mm
■ Folded width	320 mm
■ Seat width	320 - 360 mm
■ Armrest height	190 mm

■ Seat height	440 mm
■ Backrest height	360 mm
■ Seat depth	320 mm
■ Weight	15,3 kg
■ Maximum user weight	60 kg
■ Additional information	CE

Measurements in mm and kg. Deviations in sizes and weight (15 mm and 1,5 kg) are possible. Subject to technical alterations. Images for illustration purposes only. Certain features may be optional.

# Jazz S50 KIDS

COMPACT AND ROBUST  
KIDS WHEELCHAIR



C91  
green

- Easy to transport by car
- Quick-release wheels for fast removal
  - Well-made clothes protectors
- Easy-to-maintain seat upholstery
- Swing away armrests for easy transfers

**Jazz S50 Kids is the perfect companion for ambulatory use. Compact and robust, it's the perfect wheelchair for rental use.** Just like the music, the Jazz S50 Kids is colourful and timeless. A basic but solid wheelchair for ambulatory use. Basic? Yes, but it comes with collapsible armrests, adjustable footplates, removable rear wheels and is foldable for easy transport in the car. The striking green color adds to its visibility in public and youthful attractiveness.



Available with optional BZ7  
comfort legrests

## Features



Extra soft and comfortable armrests



Robust push brakes



Removable and swing away armrests



Foldable and removable footrests

## Technical information

■ Total width	518 - 558 mm
■ Total height (folded)	915 mm
■ Total length	914 mm
■ Seat width	320 - 360 mm
■ Height armrests	211 mm
■ Seat height	457 mm

■ Height backrest	360 mm
■ Seat depth	325 mm
■ Weight	15,20 kg
■ Maximum user weight	60 kg
■ Additional info	CE

Measurements in mm and kg. Deviations in sizes and weight (15 mm and 1,5 kg) are possible. Subject to technical alterations. Images for illustration purposes only. Certain features may be optional.

# Bayo

THERAPEUTIC  
INDOOR SEAT



- Cosy and comforting upholstered seat
- Easy to maneuver with 4 swivel wheels
  - Removable table for playtime or meal time
- Adjustable height without any tools
- Supports an excellent posture throughout the day



Reading, learning, communication and fun is what the BAYO seat is all about. It has become irreplaceable in the daily work with children as it offers optimal posture and stabilization.

The seat offers an exceptional stabilization of the pelvis. BAYO provides excellent comfort to the children. It is not possible to maintain a correct posture of the child without offering him a maximum seating comfort. Discomfort

always stimulates attempts to change the seating position. The upholstery is made of ALCALA material. It is soft, nice to the touch, breathable, resistant to pilling, fireproof, easy washable, waterproof, very durable, imitating natural skin and eco-friendly material.

## Features



Adjustments without additional tools



4 wheels with separate brakes



## Technical information

■ Total width	490 / 560 mm
■ Total length	700 mm
■ Total height	1030 / 1270 mm
■ Seat height	470 - 610 mm
■ Seat width	320 / 400 mm
■ Seat depth	280 - 340 / 360 - 410 mm

■ Seat angle	- 13° / +25°
■ Backrest angle	45°
■ Height armrests	130 - 300 mm
■ Weight	19,5 / 25kg
■ Maximum user weight	35 / 50 kg
■ Additional info	CE

Measurements in mm and kg. Deviations in sizes and weight (15 mm and 1,5 kg) are possible. Subject to technical alterations. Images for illustration purposes only. Certain features may be optional.

# Inovys JUNIOR

HIGH COMFORT  
KIDS WHEELCHAIR



Thanks to years of experience in care wheelchairs, we accommodate to the youngest users and the caregivers. The design of Inovys Junior is expertly thought out to suit individual needs. It brings comfort, versatility, with endless possibilities, on top of Junior friendly design.



For short or long term usage, postural management throughout the day is a must for our users. Either for pressure relief, blood circulation, or just for comfort. You can easily adjust the tilting system to suit your needs.

Gas spring tilting & inclination possibilities for more precision and more comfort for the Junior and caregiver. Adjustment and configuration do not need to be set exclusively when

comes the ordering process. During the day, the use, or with user growth, adjustment possibilities are a must to fit updated needs and to keep providing comfort. Inovys Junior version offers comfort pre-shaped seat and backrest cushions, available in many versions.

Not only does the chair allow to vary position & configuration. You can also configure and order a Inovys Junior that fits the users' needs best, thanks to the wide range of options and accessories.

## Features



*Effortlessly  
reclinable*



*Height-adjustable  
handles*

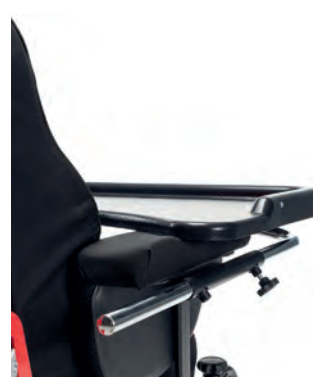

*B15A - Removable plastic  
table (optional)*



*B33 - Rubber tubes around  
the rims for better grip  
(optional)*

## Technical information

Total width	580 mm
Total length	1050 mm
Total height	990 - 1060 mm
Armrest height	220 - 320 mm
Seat width	350 mm
Seat inclination	0° - 21°

Seat height	390 - 450 mm
Backrest height	550 - 750 mm
Seat depth	350 - 470 mm
Weight	>44 kg
Maximum user weight	60 kg
Additional information	CE

Measurements in mm and kg. Deviations in sizes and weight (15 mm and 1,5 kg) are possible. Subject to technical alterations. Images for illustration purposes only. Certain features may be optional.

OPTIONS InovyS JUNIOR



**B66MAL** Gutted rotating armrest



**BZ8** articulated legrest self-correcting in length



**B33** Gel cover for push rim



**L58** Soft Headrest adjustable in depth, height and angle



**B15A** Plastic table



**B22** Abduction block



**B85** Spoke protector



**BK7** Leg rest for amputees



**BZ10** One-piece articulating legrest



**L04** Side supports



**B20** Safety belt with quick-release fastener



**B78** Anti-tipping wheels

# Gemini 2

BUGGY



**C13**  
black  
matt

**C48**  
deep  
grey

black  
grey

blue  
grey

green  
grey

- Head support
- Trunk supports
- Cosy seat with soft fabric
- Attractive design
- Feet stabilization



SCAN the QR code and  
discover the Gemini 2.

A walk in the park or a family dinner at home, Gemini 2 provides a fully customizable and adjustable solution for the family. Adjusting the seating positioning, changing the color or even adding on an indoor-frame. The Gemini 2 stroller makes it feel like anything is possible!

Thanks to our Easy & Smart positioning control, you can create the correct posture for a child. Even at a young age, perfect seating is important. Therefore Gemini 2 allows for

head, trunk, hip and feet corrections. All made possible by our wide range of positioning accessories and options for this stroller.

**2 chairs for 1:** Interchange the seat system for a hi-low base frame, changing the Gemini 2 from a stroller into an indoor inclinable chair. Fun for activities at the dinner table and quickly suited for an outdoor trip!

## Features



Adjustable pushbar



Footpedal brake



## Technical information

■ Total width	620 mm & 690 mm
■ Total height	1200 mm & 1275 mm
■ Total length	950 mm & 1060 mm
■ Folded width	620 mm & 690 mm
■ Seat width	320 mm & 400 mm
■ Height armrests	200 mm

■ Seat height	510 mm
■ Height backrest	520 - 640 mm & 650 - 770 mm
■ Seat depth	300 - 360 mm & 360 - 420 mm
■ Weight	18 kg & 27 kg
■ Maximum user weight	35 kg & 50 kg
■ Additional info	CE

Measurements in mm and kg. Deviations in sizes and weight (15 mm and 1,5 kg) are possible. Subject to technical alterations. Images for illustration purposes only. Certain features may be optional.

# OPTIONS Gemini 2



**U82**  
High-low indoor frame



**8" Inflatable/PU**  
front wheels



**12" Inflatable/PU**  
rear wheels



**B28A or B28B**  
Hip cushion 2 cm or 4 cm



**B28C or B28D**  
Trunk cushion 2 cm or 4 cm



**U53** Abduction block



**U61** Shopping basket



**U62** Legs cover



**U67** Canopy



**U68** Directional  
wheel lock



**U64**  
Safety barrier

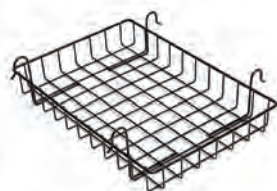

**U70**  
Respirator shell



**U71** Trunk  
stabilization profile



**U84** Tubular  
arm rest



**U85** Adjustable  
trunk pelots



**U86** Adjustable  
hip pelots



**U87** Additional  
small trunk pelots



**U88** Frame protection



**U89** Lumbar cushion



**U90** Plastic table



**U91** Feet  
positioning system

# Forest KIDS

POWERED  
KIDS WHEELCHAIR



- Adjustable to suit its users
- Reclinable seat and backrest with powered springs
- Durable upholstery
- Excellent performance in-and outdoor
- Qualitative and trustworthy
- Stability during driving



Ready for all terrains! The Forest Kids is an electric wheelchair with an attractive design. The seat can be optimally adjusted for maximum seating comfort for every child.

Some features include: height-adjustable handles, adjustable seat and backrest thanks to the electric actuators. Our pivoting front axle ensures all four wheels are always in contact with the ground, guaranteeing optimum stability on all terrains.



## Features



*Electric-powered reclinable backrest and seat*



*Front and rear lights for safety and visibility*



*Anti-tipping and transit hooks for additional safety*

## Technical information

■ Total width	600 mm
■ Total length	1050 mm
■ Total height	930 - 1080 mm
■ Seat height	510 mm
■ Seat width	320 / 350 / 370 mm
■ Seat depth	330 - 390 mm

■ Batteries	2x12V/75Ah/220W/350W
■ Speed*	6 km/h or 10 km/h
■ Driving range*	30 km
■ Weight	95 kg
■ Maximum user weight	50 kg
■ Additional information	CE

\* The driving range is calculated according to European standards. \* Speed and driving range may deviate (ca. 15%). Permitted dimensional and weight tolerances: 15 mm, 1.5 kg and 1.5°. Subject to technical alterations. Images for illustration purposes only. Certain features may be optional.

# Springer

POWERED  
KIDS WHEELCHAIR



- 300mm seat lift included
- Electric-powered reclining seat
- LED front and rear lights
- Anti-tipping wheels
- Ground clearance of 80 mm
- Sturdy front and rear wheels with deep tread on the rear wheels for extra stability

A wheelchair designed to suit the individual needs of each child. With its many adjustable features, Springer allows for optimal adjustments to ensure ultimate comfort and driving fun. Springer is a perfect choice for kids or smaller users. The included powered height adjustable seating allows for easy access to higher work surfaces and for greater social interaction.



Optional electric powered  
inclinable seat and backrest



300 mm seat  
lift included

## Technical information

■ Total width	600 mm
■ Total length	1010 mm
■ Total height	960 - 1230 mm
■ Seat height	530 - 810 mm
■ Seat width	260 - 380 mm
■ Seat depth	310 - 370 mm

■ Batteries	2x12V/50Ah/220W or 2x12V/50Ah/350W
■ Speed*	6 km/h or 10 km/h
■ Driving range*	23 km
■ Weight	90 kg
■ Maximum user weight	50 kg
■ Additional information	CE

\* The driving range is calculated according to European standards. \* Speed and driving range may deviate (ca. 15%). Permitted dimensional and weight tolerances: 15 mm, 1.5 kg and 1.5°. Subject to technical alterations. Images for illustration purposes only. Certain features may be optional.



05 \ COMFORT WHEELCHAIRS



## COMFORT WHEELCHAIRS

Inovys II Evo	94
Inovys II E Evo	98
Inovys II L70	100
Eden (E)	101
Altitude (E)	102
Coraille (E)	103

**Discover our range of comfort chairs and our shell chairs. Intended for individuals or communities, our chairs are designed to adapt perfectly to the users and their pathologies in order to bring them maximum comfort.**

Our chairs are designed for both our users and their carers. We invest in improving the daily life and comfort of both. Our designs are comfortable and easy to use with a perfect balance in mind.



Inovys II Evo

Comfort chairs

# Inovys II Evo

## MAXIMUM COMFORT

With its preshaped seat and backrest, comfortable leg rests and fully adjustable headrest, Inovys II Evo has been designed to provide maximum comfort to its user. The well-designed chair can be adapted to support individual needs.



## MANUAL OR ELECTRIC TILT

Inovys II Evo is available in 2 versions: the classic version with seat and backrest tilt with assistance cylinders (ideal for a care giver) or the Inovys II-E Evo with an electric seat and backrest tilting system operated by either carer or user.



## PERSONALISED CONFIGURATION

With a wide range of adjustment and accessory options Inovys II can be easily adapted to each users unique needs.



# Inovys II Evo

COMFORT  
WHEELCHAIR



C89  
copper

- Headrest adjustable in inclination, height, and depth
- Removable and adjustable (height and width) armrests
- Adjustable leg rests
- Seat cushion with soft foam
- Modern and new updated colors

The Inovys II Evo is a highly adjustable and comfortable care wheelchair, designed to meet a wide range of user needs. It features a backrest that reclines from 0° to 45° and a seat inclination of 0° to 21°, supported by gas struts for smooth adjustments.

With its pre-formed seat and back cushions, the Inovys II Evo offers exceptional comfort. The adjustable headrest, backrest height, leg supports, and leg rests ensure a

tailored fit for users of almost any body type. A variety of accessories and customisation options provide even greater adaptability to suit individual requirements. Full details of available options can be found on the next page.

## Also available in MAXI COMFORT version:

Equipped with a L58C comfort headrest adjustable in width and rotation and a BZ8C comfort leg rest for ultimate comfort.

## Features



*Preshaped backrest with adjustable hip cushions*



*Adjustable seat height without changing the wheel position*



*Available in T30 version*



*Adjustable leg rests in length, 4 widths, depth, and inclination with cushion for extra comfort*

## Technical information

■ Total width	580 / 630 / 680 / 730 mm
■ Total length	1010 - 1050 mm
■ Total height	990 - 1060 mm
■ Seat inclination	0° - 21°
■ Seat width	350-400 / 400-450 / 450-500 mm
■ Armrest height	220 - 320 mm

■ Seat height	460 - 530 mm
■ Backrest height	550 - 585 mm
■ Seat depth	460 - 520 mm
■ Weight	>43,7 kg
■ Maximum user weight	135 kg
■ Additional information	CE

Measurements in mm and kg. Deviations in sizes and weight (15 mm and 1,5 kg) are possible. Subject to technical alterations. Images for illustration purposes only. Certain features may be optional.

# OPTIONS Inovys II Evo (E)



**B66MAL** Hemiplegic armrest with palm support



Comfort armrests



**B06** Standard removable footrest



**BZ8C ART** Legrest COMFORT auto-adjusting leg- & footrest



**BZ10** legrest with 7 cm side supports



**L58** Adjustable headrest SOFT



**L58C** Soft headrest, adjustable in height and depth



**B12** Black wooden swing away table with cut-out

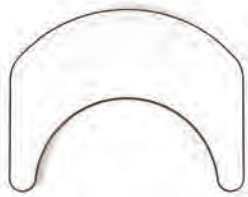

**B12A** White wooden, swing away table, with cut-out



**B20** Quick-lock safety belt



**B58** Safety belt with quick release (5 cm)



**B22** Abduction block



**B42** Transport bag



**B78** Anti-tipping wheels



**B52** Drip holder



**L04** Lateral supports



**L14** Anatomically shaped backrest in artificial leather



**L14 SOFT** anatomically shaped backrest in soft artificial leather



**L34** Anatomically pre-shaped backrest in soft artificial leather



**L15** Anatomical seat in artificial leather

■ Consult our order forms to discover all the possible options on [www.vermeiren.com](http://www.vermeiren.com) ■

# INOVYS II E Evo

POWERED  
COMFORT  
WHEELCHAIR



C89  
copper

- Seat cushion with semi-memory foam
- Adjustable headrest in depth and height
- Easy-to-use controller for user and attendant
- Removable and adjustable armrests (height and depth)
- Leg rests adjustable in height and positioning

Inovys II-E Evo is a comfort wheelchair with many adjustments included. The backrest can recline from 0° up to 54° whilst the seat can recline from 0° up to 21°. These inclinations are easy to adjust since the Inovys II E has a powered system.

Inovys II-E Evo has the possibility to recline around its epicentre, meaning that the patient can change position throughout the day or use it without tugging on the skin. Position changes are beneficial for blood pressure, blood circulation and general comfort.



## Features



Optional anti-decubitus cushion



Easy-to-use controller



Adjustable headrest (height and depth) with lateral supports



Comfortable removable armrests (adjustable in height, depth, and width)

## Technical information

■ Total width	630 / 680 / 730 mm
■ Total length	1010 - 1050 mm
■ Total height	990 - 1060 mm
■ Seat inclination	0° - 21°
■ Seat width	400 / 450 / 500 mm
■ Armrest height	220 - 320 mm

■ Seat height	460 - 530 mm
■ Backrest height	550 - 585 mm
■ Seat depth	460 - 520 mm
■ Weight	43,9 kg
■ Maximum user weight	135 kg
■ Additional information	CE

Measurements in mm and kg. Deviations in sizes and weight (15 mm and 1,5 kg) are possible. Subject to technical alterations. Images for illustration purposes only. Certain features may be optional.

## OPTIONS Inovys II Evo (E)



**L15 SOFT**  
Anatomical seat



**L35 Preshaped**  
anatomical seat



**B33 Push rims**  
in gel 24"



**B85 Spoke**  
protector



**B74 Hand brakes**



**B41 Air pump**



**BK7 Leg rest for**  
amputees (left or right)



**V12 - V14 Protective cover**  
gel for tubes 6'' - 8''  
(pair) 120 x 160 mm  
120 x 200 mm



**V16 Gel cover for crutch or**  
walker (pair) 120 x 140 mm



**V18 Gel cover for crutch or**  
walker (pair) 120 x 130 mm



**V20 Gel cover for**  
safety belt (2 pieces)



**V22 Gelovation gel pad**  
for gutted arm rest (pair)  
110 x 340 mm



**V24 Gelovation gel pad**  
side for leg support (pair)  
310 x 90 mm



**V26 Gelovation gel**  
pad wide calf support  
400 x 190 mm



**V28 Gelovation protective**  
cushion for footplate  
(pair) 155 x 210 mm



**V30 Gelovation self**  
adhesive protective cushion  
for side support, oval  
80 x 100mm (pair)



**V32 Gelovation self**  
adhesive protective cushion  
for side support, oval  
100 x 200mm (pair)



**V36 Gelovation self**  
adhesive protective  
cushion for side support,  
egg-shaped 120 x 70 mm



**V38 Gelovation gel pad**  
for arm support,  
90x300mm (pair)



**V40 Gelovation gel**  
pad knee protection  
(pair) 100 x 100 mm

■ Consult our order forms to discover all the possible options on [www.vermeiren.com](http://www.vermeiren.com) ■

# INOVYS II L70

## GRANULATED SEATING SYSTEM

- All cushions are filled with resilient polystyrene granules that provide perfect support for the body and connect to the its contours.
- By adding or reducing the granules, the pressure on body contours can be increased or decreased.
- Due to the various adjustment options the wheelchair can be optimally adjusted.
- The comfort arms provide a secure and pleasant feeling that allows the user to completely relax.



**VERMEIREN** created the L70 positioning system in combination with the existing Inovys II wheelchair. For people who are bound to a passive sitting position, the Inovys L70 offers ideal seating comfort. The polystyrene-filled cushions in the back, seat, and leg area ensure pressure distribution and follow the contours of the body.

The Inovys II L70 is equipped with a fully adjustable headrest both in height and in angle and this without additional tools. Optionally, an L58G can also be mounted that automatically assumes any desired shape. A range of options means that the Inovys II L70 can be fully adapted to the needs and wishes of almost every user.

Individual adjustments are perfectly possible due to the adjustability of the angle of the foot section, the leg section, the seat section and the inclination of the back section. The drum brakes for the attendant and additional parking brakes ensure that the user can sit in the chair in complete safety.

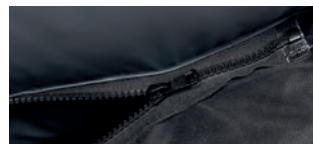

*Easy removal of the compartments by means of a zipper*

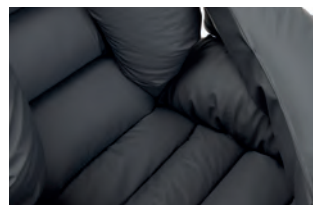

*Each compartment features bead-filled cushions that provide optimum body & contour support.*



*An optional washable cover in gray terry cloth is available and thus ensures more hygiene during daily use of the Inovys II L70.*

### Technical information

■ Total width	680 - 730 mm
■ Total height (without headrest)	990 - 1060 mm
■ Total length	1280 mm
■ Seat inclination	0° - 30°
■ Legrest - footplate inclination	73° - 107°
■ Height armrests	220 - 320 mm

■ Seat height	510 - 580 mm
■ Height backrest	550 - 600 mm
■ Seat depth	460 - 520 mm
■ Weight	38 kg
■ Maximum user weight	135 kg
■ Additional info	CE

Measurements in mm and kg. Deviations in sizes and weight (15 mm and 1,5 kg) are possible. Subject to technical alterations. Images for illustration purposes only. Certain features may be optional.

# Eden

## ADJUSTABLE SHELL CHAIR

Eden is the combined result of design, comfort and aesthetics for users in need of more support.

The adjustable shell chair allows for easy positioning of the user, whilst maintaining his autonomy. The design and appearance encourage interaction with its environment adding to its value in a care setting.



Wheels with separate brakes



Foldable table



■ Total width	770 - 940 mm
■ Total length	710 - 1330 mm
■ Total height	1350 mm
■ Seat width	380 / 440 / 480 mm
■ Seat height	400 - 430 mm
■ Seat angle	-3° / +30°

■ Seat depth	460 mm
■ Backrest height	830 mm
■ Armrest height	230 mm
■ Weight	34 kg
■ Maximum user weight	120 kg
■ Additional information	CE

# Eden E

## SHELL CHAIR WITH POWERED SUPPORT

The Eden E shell chair has the same qualities as the Eden chair with the added benefit of a powered tilted seat and leg support. Easy to control with the controller. The preshaped backrest with lumbar support ensures that sitting in Eden E does not cause any discomfort. The headrest is removable and the side table can be folded when not in use.



Easy to use controller

■ Total width	770 - 940 mm
■ Total length	710 - 1330 mm
■ Total height	1350 mm
■ Seat width	380 / 440 / 480 mm
■ Seat height	400 - 430 mm
■ Seat angle	-3° / +30°

■ Seat depth	460 mm
■ Backrest height	830 mm
■ Armrest height	230 mm
■ Weight	36 kg
■ Maximum user weight	120 kg
■ Additional information	CE

Measurements in mm and kg. Deviations in sizes and weight (15 mm and 1,5 kg) are possible. Subject to technical alterations. Images for illustration purposes only. Certain features may be optional.

# Altitude

## SHELL CHAIR



PU SOFT TOUCH  
green

PU SOFT TOUCH  
prune

PU SOFT TOUCH  
praline

PU SOFT TOUCH  
orange

Two-tone upholstery  
black

Two-tone upholstery  
brown

C29  
grey  
frame

C60  
dark brown  
frame

C75  
black  
frame

- Foldable footrests with gas struts
- Removable headrest
- Brakes on all four wheels
- Ultimate comfort

**VERMEIREN** has designed **Altitude** with the greatest **comfort possible in mind for its user**. This chair comes with a thick padded cushion, a three-point safety harness and a molded adjustable headrest. The footrest is equipped with gas struts to allow for easy transfers.

**Altitude** is also available in **XL version** or **E-version (powered shell chair)**

### Features



*The table remains horizontal even when the chair is reclined*



**Option B52**  
drip holder



**Removable**  
seat cover



**Optional**  
table (378)



**Available as**  
e-Version

### Technical information

■ Total width	710 mm
■ Total length	1090 mm
■ Total height	1290 - 1315 - 1340 mm
■ Seat inclination	0° - 40°
■ Seat width	380 / 400 / 420 / 440 / 480 mm
■ Armrest height	235 / 255 / 275 mm

■ Seat height	445 - 535 mm
■ Backrest height	792 / 812 / 832 mm
■ Seat depth	440 / 460 / 480 mm
■ Weight	33,9 kg
■ Maximum user weight	120 kg
■ Additional information	CE

Measurements in mm and kg. Deviations in sizes and weight (15 mm and 1,5 kg) are possible. Subject to technical alterations. Images for illustration purposes only. Certain features may be optional.

# Coraille

## SHELL CHAIR



PU SOFT TOUCH  
green

PU SOFT TOUCH  
prune

PU SOFT TOUCH  
praline

PU SOFT TOUCH  
orange

Two-tone upholstery  
black

Two-tone upholstery  
brown

C29  
grey frame

C60  
dark brown frame

C75  
black frame

- Foot pedal brake
- Reclining seat up to 40°
- Five-point safety belt
- Directional wheels

Coraille is a high comfort care chair with padded sides making it a good option for long-term use. The chair as standard is equipped with a thick cushion, a three-point safety belt and a removable preshaped headrest.

The footrests are equipped with a gas spring to fold away easily, allowing for

easy transfers in and out of the chair. The Coraille chair is height adjustable and has large rear wheels with a pedal brake. The wheels allow for outdoor usage, overcoming minor obstacles, without compromising on comfort.

Coraille is also available as e-Version (powered) for easier lifting or repositioning.



Available as e-Version

### Features



Option B52 drip holder



Optional table (378)



The table remains horizontal even when the chair is reclined

### Technical information

■ Total width	710 mm
■ Total length	1090 mm
■ Total height	1290 - 1315 - 1340 mm
■ Seat inclination	0° - 40°
■ Seat width	380 / 400 / 420 / 440 / 480 mm
■ Armrest height	235 / 255 / 275 mm

■ Seat height	465 - 490 - 515 mm
■ Backrest height	792 / 812 / 832 mm
■ Seat depth	440 / 460 / 480 mm
■ Weight	39 kg
■ Maximum user weight	120 kg
■ Additional information	CE

Measurements in mm and kg. Deviations in sizes and weight (15 mm and 1,5 kg) are possible. Subject to technical alterations. Images for illustration purposes only. Certain features may be optional.



06 \ BEDS AND HOMECARE



## BEDS AND HOMECARE

Illico	106
Izyco	110
Club / Club Vario	112
Club UL	113
2030	113
Eagle 620 / Eagle 625	114
Albatros / Albatros II	114
Falcon	115
Patient lift slings	115
Normandie / Languedoc	116
Normandie 2F / Bretagne	117
Ontario 2	119
Table 376 / Cabinet 385 / Lift 631	120
Rolling table 378 / Alesia	121
Ramps 690 / 692	123

**VERMEIREN offers a complete range of beds with creations that are ever more practical and easy to assemble, as well as products designed for standing up, geriatric chairs and rest chairs.**

Our products have many features in their standard configuration and can also be equipped with options to facilitate their use.



ILLICO

Bed with 2 or 3 functions

# Illico

## MODULAR BED, ADAPTED TO YOUR NEEDS

The ILLICO bed has been designed to be a modular system to be adaptable to individual needs. Install a third motor to transform a manual leg rest into a fully electric leg rest without any tools.



## YOUR DESIGN WITH MODERN PANELLING

For a more modern look and to facilitate the installation of air mattresses, we've redesigned our standard panels. Available in different colors and with a new design, they will suit your interior even better.



## EASY ASSEMBLY, TOOL-FREE AND FAST

The ILLICO bed delights caretakers with its easy assembly and ultra-fast modular system. Install, store, or adapt Illico without any tools.

# Illico

BED WITH 2 OR 3 FUNCTIONS

**C29**  
grey

**C47**  
white



SCAN the QR code  
and discover the Illico bed.



- Fast assembly and easy-to-install
  - Metal or wooden barriers
  - 3 panels to choose from
- Variable height with controller
- Delivered in transport kit
  - Easy-to-assemble

The Illico bed is a bed suitable for care facilities, designed to be assembled quickly. The bed can easily be upgraded depending on its user's needs.

There are multiple configurations available and countless options. Easily change your bed from 2 to 3 functions if needed. The bed can be stored compactly thanks to its foldable and easy-to-use design.

## Features



Controller with 3 buttons  
for 3 lifting functions



Locking system for paneling  
tool-free. Fast to use.



From 2 to 3 functions  
(or reverse)



Variable height from 29 cm to  
82 cm with electrical support



Possibility to store 2 beds  
on top of each other.

## Technical information

■ Total width	1024 mm
■ Total length	2080 mm
■ Total height	783 - 1313 mm
■ Mattress frame height	298 - 828 mm
■ Maximum angle for the upper body	70°
■ Maximum angle for upper legs	36,8°

■ Maximum angle for lower legs	-17°
■ Mattress	RG 35, thickness 120 mm, 2000 x 900 mm, max. 20 kg
■ Nominal load lifting pole	75 kg
■ Weight	85 kg
■ Maximum user weight	135 kg
■ Additional information	CE

Measurements in mm and kg. Deviations in sizes and weight (15 mm and 1,5 kg) are possible. Subject to technical alterations. Images for illustration purposes only. Certain features may be optional.

OPTIONS Illico



Panel Beech + metal side panels



Panel Oxyde + wooden side panels



Panel Beech + wooden side panels

**ALSO AVAILABLE**  
B52 serum holder  
20 cm bed extension



ABS (Optional)



CB4 Central brake



WP Wall protection



Horizontal transportation kit



2 functions (height and backrest, Leg rest adjustable manually)



3 functions: height, backrest and electrical knee folding. (Convertible in full electric leg rest in few minutes)



3 functions: height, backrest and electrical leg rest (convertible into electric folding in a few minutes)

# Izyco - Trolley Free Bed

“Assembling a bed has never been so easy.”



 YouTube

Scan the QR code and discover the simple steps on how to assemble your Izyco bed.



- Fast assembly and easy-to-install
- Solid metal frame
- Tool free disassembly with the two heaviest components weighing 18 and 16 kg
- TFB - Trolley Free Bed transport and bed all in one



Izyco is a toolfree bed made for renting market based on our Illico concept but with a patented trolley system that allows to transport the bed from one user to another without any extra separated trolley to move it. The lower frame is designed in such a way that it serves as a trolley. This quite unique feature saves up space and time.

**Electrical height adjustment:** Mattress support adjustable from 298 mm to 828 mm

**Enhanced comfort:** Multiple adjustment options allow for personalized positioning

**Safety:** Lockable handset and side-rails reduce the risk of accidents

**Ease of use:** Electric controls simplify adjustments for both patients and caregivers

**Quick setup:** Tool-free (dis)assembly saves time and effort.

**Mobility:** Lockable wheels facilitate movement and secure placement

**Aesthetic appeal:** Wooden components offer a homely appearance, blending in with most interiors



Single person assembly thanks to the unique and simple to use folding system.

## Technical information

■ Total width	1024 mm
■ Total length	2080 mm
■ Total height	783 - 1313 mm
■ Mattress frame height	298 - 828 mm
■ Maximum angle for the upper body	70°
■ Maximum angle for upper legs	36,8°

■ Maximum angle for lower legs	-17,2°
■ Mattress	RG 35, thickness 120 mm, 2000 x 900 mm, max. 20 kg
■ Nominal load lifting pole	75 kg
■ Weight	110 kg
■ Maximum user weight	135 kg
■ Additional information	

# Club

## CLASSIC BED



Available with a metal or wooden slat base



**Club is an electrically height adjustable care bed suitable for use both in homes or care facilities.**

Combining our experience in home care solutions and input from care givers, Club meets the highest standards for a care bed solution. The high quality, 3 motors and other standard features make Club the perfect choice to support care professionals whilst bringing optimal comfort to the patient.

■ Total width	1005 mm
■ Total length	2125 mm
■ Total height (without pole)	834 - 1262 mm
■ Height adjustment bed surface	350 - 810 mm
■ Anti-Trendelenburg	yes
■ Max. backrest adjustment	69°

■ Max. thigh adjustment	20,7°
■ Max. lower leg adjustment	-16,5°
■ Weight	60,8 kg
■ Maximum user weight	165 kg
■ Nominal load lifting pole	80 kg
■ Additional information	CE



The frame can be positioned at two different heights



# Club VARIO

## VARIABLE FRAME HEIGHT

**Club VARIO is the Height Adjustable version of the Club.**

VARIO stands for the possibility to set the bed base at 2 different heights, 33.5 cm for the most popular set up, and 40 cm for taller end users.

- Anti-trendelenburg position
  - Beechwood frame
  - Frame powder-coated
- Supplied on a transport kit
  - LINAK actuators

■ Total width	1037 mm
■ Total length	2175 mm
■ Total height (without pole)	834 - 1262 mm
■ Height adjustment bed surface pos. 1	335 - 745 mm
■ Height adjustment bed surface pos. 2	400 - 810 mm
■ Max. backrest adjustment	69°

■ Max. thigh adjustment	20,7°
■ Max. lower leg adjustment	-16,5°
■ Weight	62 kg
■ Maximum user weight	165 kg
■ Nominal load lifting pole	80 kg
■ Additional information	CE

Measurements in mm and kg. Deviations in sizes and weight (15 mm and 1,5 kg) are possible. Subject to technical alterations. Images for illustration purposes only. Certain features may be optional.

# Club UL

## LOWEST HEIGHT

Club UL is a 4 section low height care bed designed for fall prevention. This bed proves to be an excellent choice for patients experiencing disorientation or those susceptible to falling while in bed. Its low height serves a dual purpose, significantly reducing the risk of injury when exiting the bed and ensuring effortless reentry. For added convenience, Club UL is delivered on a transport kit, streamlining the installation and assembly process.



■ Total width	1037 mm
■ Total length	2175 mm
■ Total height	725 - 1135 mm
■ Height of mattress support (without mattress)	215 - 625 mm
■ Mattress spec.	RG 35, thickness 120 mm, 2000x900 mm
■ Anti-Trendelenburg	yes

■ Maximum angle for upper legs	20,7°
■ Maximum angle for lower legs	-16,5°
■ Max. backrest adjustment	69°
■ Weight	73,5 kg
■ Maximum user weight	165 kg
■ Additional information	CE



Controller with locking function



# 2030

## MODULAR

The 2030 modular bed is designed with the users' comfort in mind. Due to the modular system, there are countless customization options for everyone.

The bed is a four-part electric bed that can completely be disassembled. The controller has an anti-trendelenburg function as well as an adjustable height button.

Optional: a bed extension of 100 mm is also available.



■ Total width	1010 mm
■ Total length	2152 mm
■ Total height	840 - 1240 mm
■ Mattress frame lowest position	350 mm
■ Mattress frame highest position	750 mm
■ Anti-Trendelenburg	yes

■ Maximum angle for upper legs	20°
■ Maximum angle for lower legs	28°
■ Weight	70 kg
■ Maximum user weight	135 kg
■ Additional information	CE

Measurements in mm and kg. Deviations in sizes and weight (15 mm and 1,5 kg) are possible. Subject to technical alterations. Images for illustration purposes only. Certain features may be optional.

# Eagle 620

PATIENT LIFT 150 KG



C29  
grey

# Eagle 625

PATIENT LIFT 175 KG



**The patient lift 620/625 patient lift combines functionality, safety, and reliability.**

The qualitative wheels combined with a narrow total width allow for easy transfers, even in narrow spaces. Different lifting slings are available for our patient lifts. Whether you opt for the standard, hygienic, or comfort version with upper body support, our lifting straps offer a solution suitable for everyone's needs for support.



■ Total length	1115 mm
■ Total width (closed) / (opened)	550 / 1035 mm
■ Highest CAP position	1740 mm
■ Weight	37 kg
■ Maximum user weight	150 kg
■ Additional information	CE

■ Total length	1290 mm
■ Total width (closed) / (opened)	680 / 1225 mm
■ Highest CAP position	1840 mm
■ Weight	42 kg
■ Maximum user weight	175 kg
■ Additional information	CE

# Albatros

ACTIVE LIFT

**The Albatros is a compact patient hoist with easy usage.** Foldable in a few seconds for easy storage and transport.

C29  
grey

C64  
white

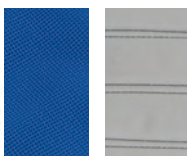

SLING SIZES	
Available in M - XL (standard or netted structure)	
M	XL
40-120 KG	100-200 KG

The ACTIVE sling is available in 2 sizes and is washable at 60° Celsius. The **medium size** supports patients from 40 up to 120kg, whilst the **XL size** supports those from 100 up to 200 kg.



# Albatros II

ACTIVE AND THERAPY LIFT

**Patient lift with a vertical lift that's easy to use.** Albatros II folds in a few seconds for easy transport or storage. The design allows for stable lifting of a patient in a vertical position.

C29  
grey

C64  
white

**For Albatros II we offer a variety of sling systems that meet the highest quality standards** and requirements for patient transfers. Available in a padded version or with a netted fabric depending on the individual needs.



■ Total length	1046 mm
■ Total width (closed) / (opened)	584 / 945 mm
■ Total height	1040 - 1739 mm
■ Weight	44,85 kg
■ Maximum user weight	150 kg
■ Additional information	CE

■ Total length	1046 mm
■ Total width (closed) / (opened)	584 / 945 mm
■ Total height	1040 - 1739 mm
■ Weight	44,85 kg
■ Maximum user weight	150 kg
■ Additional information	CE

# Falcon

PATIENTLIFT



Falcon is a perfect mix between safety, security, and technology. This compact patient lift allows for easy and comfortable transferring of patients. The two brakes assure a locked position for ultimate safety when lifting or lowering. With its balanced design, maneuvering becomes smooth sailing for both patient and attendant.

- Neoprene protection on the bar
- Ergonomic push handles
- Controller with battery indicator
- 48 seconds, high to low position
- Audible warning low battery

# Sling STANDARD

SLING FOR EAGLE 602 - 625 & FALCON



Available in the following sizes  
**M - L - XL**  
(standard of mesh structure)

The different sizes are indicated with color on the slings.

- Medium (M) yellow
- Large (L) blue
- Extra Large (XL) black

**Patient weight:**

**M (yellow) 40 - 90 kg**  
**L (blue) 70 - 120 kg**  
**XL (black) 100 - 200 kg**

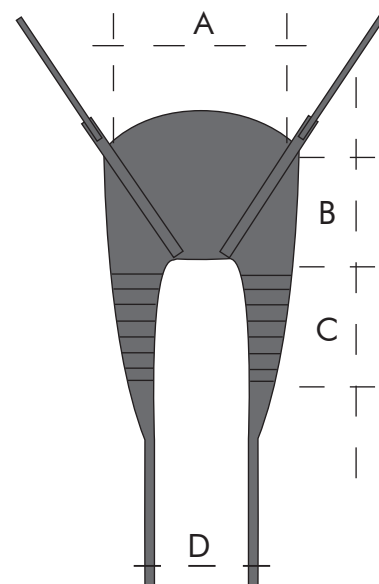

■ Total length	1158 mm
■ Total width (closed) / (opened)	565 / 1026 mm
■ Highest CAP position	1609 mm
■ Weight	35 kg
■ Maximum user weight	130 kg
■ Additional information	CE

	A	B	C	D
M	780	400	450	300
L	840	450	500	360
XL	910	510	560	440



# Sling COMFORT

SLING FOR EAGLE 602 - 625 & FALCON  
ADDITIONAL NECK SUPPORT



Available in the following sizes  
**M - L - XL**  
(standard of mesh structure)

The different sizes are indicated with color on the slings.

- Medium (M) yellow
- Large (L) blue
- Extra Large (XL) black

**Patient weight:**

**M (yellow) 40 - 90 kg**  
**L (blue) 70 - 120 kg**  
**XL (black) 100 - 200 kg**

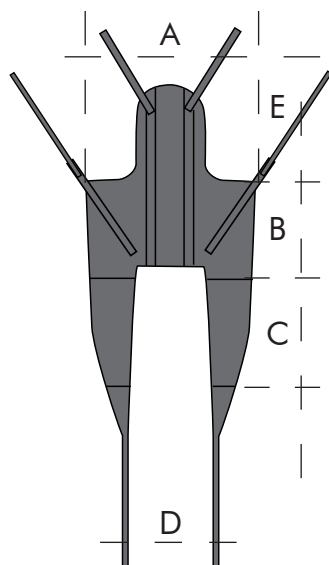

# Sling HYGIENE

SLING FOR EAGLE 602 - 625 & FALCON  
TOILET VISITS

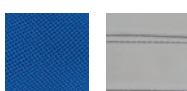

Available in the following sizes  
**M - L - XL**  
(standard of mesh structure)

The different sizes are indicated with color on the slings.

- Medium (M) yellow
- Large (L) blue
- Extra Large (XL) black

**Patient weight:**

**M (yellow) 40 - 90 kg**  
**L (blue) 70 - 120 kg**  
**XL (black) 100 - 200 kg**

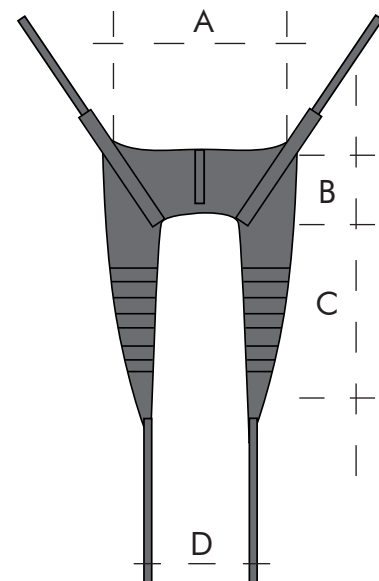

	A	B	C	D	E
M	780	400	450	300	390
L	840	450	500	360	410
XL	910	510	560	440	420



	A	B	C	D
M	780	250	600	300
L	840	260	700	360
XL	910	270	820	440



# Normandie

## GERIATRIC CHAIR

Normandie is a comfortable, well-designed chair that does not look out of place in a living room or a care facility. Its sleek design provides comfort whilst suiting any interior design. This chair is available in a version with 4 wheels or without wheels.

The armrests can be fully lowered (as shown on Normandie 2F on the next page) to facilitate easy lateral transfers. Both the backrest and leg rest can be adjusted simultaneously to adjust the seating position of the user throughout the day or use. The comfortable cushioned seat promotes comfort without fatigue.



Optional B06 footplate



Total width	685 mm
Total length	860 mm
Total height	1200 / 1205 mm
Seat width	500 mm
Seat height	500 / 520 mm
Seat angle	13° / 45°

Seat depth	480 mm
Backrest height	750 mm
Armrest height	150 - 210 mm
Weight	27,8 kg
Maximum user weight	130 kg
Additional information	CE

# Languedoc

## GERIATRIC CHAIR WITH 45° BACKREST

A comfortable chair should not be more complicated than it needs to be. Without the extra leg rest, Languedoc combines the best features of Normandie whilst saving you some costs. With the small rear wheels, the chair is easily maneuverable. With an inclinable backrest (up to 45°) and adjustable armrests, this geriatric chair is adaptable to each user and needs for comfort. Also available in different colors.

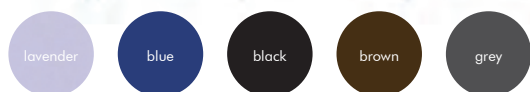

Total width	685 mm
Total length	860 mm
Total height	1200 / 1205 mm
Seat width	500 mm
Seat height	500 / 520 mm
Seat angle	13° / 45°

Seat depth	480 mm
Backrest height	750 mm
Armrest height	150 - 210 mm
Weight	22,4kg
Maximum user weight	130 kg
Additional information	CE

# Normandie 2F

## GERIATRIC CHAIR

The Normandie 2F offers the same seating comfort and quality as the standard Normandie with the exception that the inclination of the seat and the backrest work independently from each other.

By doing so, it gives you more comfort by adjusting the inclination of either the backrest or the legrest.



black



Optional donor armrests, left, right or on both sides



Optional steering wheels (4)

■ Total width	685 mm
■ Total length	860 mm
■ Total height	1200 / 1205 mm
■ Seat width	500 mm
■ Seat height	500 / 520 mm
■ Seat angle	13° / 45°

■ Seat depth	480 mm
■ Backrest height	750 mm
■ Armrest height	150 - 210 mm
■ Weight	30,4 kg
■ Maximum user weight	130 kg
■ Additional information	CE

# Bretagne

## GERIATRIC CHAIR

Bretagne is a comfortable chair from VERMEIREN that can be placed into any interior without looking out of place. This comfortable chair with a touch of luxury allows you to choose a chair that suits your needs and style.



dark brown artificial leather

light brown artificial leather

black artificial leather

wood oxyde

wood beech



Optional: wheels with brakes



■ Total width	700 mm
■ Total length	800 mm
■ Total height	1330 mm
■ Seat width	540 mm
■ Seat height	530 mm
■ Seat angle	12°

■ Seat depth	480 mm
■ Backrest height	750 mm
■ Armrest height	150 - 210 mm
■ Weight	32,5 kg (34,7 kg with wheels)
■ Maximum user weight	130 kg
■ Additional information	CE

Measurements in mm and kg. Deviations in sizes and weight (15 mm and 1,5 kg) are possible. Subject to technical alterations. Images for illustration purposes only. Certain features may be optional.



Stuff your eyes with  
**WONDER**

LIVE AS IF YOU'D

**DROP DEAD**

IN TEN SECONDS.

See the world.

IT'S MORE FANTASTIC THAN ANY

**DREAM**

MADE OR PAID FOR IN FACTORIES.

RAY BRADBURY

# Ontario 2

LIFT CHAIR



beige fabric

brown fabric

black artificial leather

taupe artificial leather

brown artificial leather

- Easy to clean
- Comfortable upholstery
- Stylish look

The lift chair Ontario 2 with 2 motors ensures that the leg and back section move independently.

With the easy-to-use remote, the chair can recline into a fully horizontal position or help you stand up by lifting the full chair in a forward inclination. With two functions in one chair, Ontario 2 is a must-have.



Headrest cover (optional)



Armrest cover (optional)

## Technical information

■ Total width	850 mm
■ Total length	830 mm
■ Total height	1140 mm
■ Seat height	500 mm
■ Seat width	485 mm
■ Armrest height	150 mm

■ Seat depth	510 mm
■ Backrest height	700 mm
■ Weight	53,98 kg
■ Maximum user weight	150 kg
■ Type of power supply	mains power
■ Additional information	CE

Measurements in mm and kg. Deviations in sizes and weight (15 mm and 1,5 kg) are possible. Subject to technical alterations. Images for illustration purposes only. Certain features may be optional.

# 376

## SIDE TABLE

This side table is modern and sleek looking, suitable for any interior. 376 is height adjustable, can be tilted and has wheels that allow for easy maneuvering. Ideal for use in combination with a bed, sofa, or lounge chair. The tilted angle allows for comfortable reading, whilst one side remains horizontal.



■ Total length	920 mm
■ Total width	470 mm
■ Total height	610 - 950 mm
■ Ground clearance	110 mm
■ Table dimensions	760 x 410 mm
■ Wheels	ø 50 mm

■ Weight	9,4 kg
■ Maximum load	15 kg
■ Additional information	CE

# 385

## BEDSIDE CABINET WITH BED TABLE

The nightstand 385 is a perfect match for your bed. Equipped with wheel brakes that ensure safety and stability when used. With a handy drawer, table, and cupboard, you have everything you might need within reach.



■ Total width / length / height	470 x 585 x 915 mm
■ Table dimensions	670 x 360 x 20 mm
■ Wheels / brakes	4 / 2
■ Weight	36,35 kg
■ Maximum table load	10 kg
■ Additional information	CE

# 631

## ACTIVE AND THERAPY LIFT

This model 631 is a lifting rod that can be used in many situations: as a lifting aid when moving from lying down to a seated position or in combination with a bed or chair. The triangle handle can be adjusted in length or height. Easy to assemble in a few minutes and without additional tools.



■ Total length	884 mm
■ Total width	710 mm
■ Total height	2005 mm
■ Weight	11 kg
■ Maximum table load	80 kg
■ Additional information	CE

# 378

## ROLLING TABLE

This wooden table with a metal frame can be used interchangeably with several VERMEIREN products such as a geriatric chair, lift or lounge chair. The table can be adjusted to various positions to suit your needs. The table has individual brakes and is adjustable in height.



■ Total width	600 - 850 mm
■ Total length	950 mm
■ Total height	640 - 820 mm
■ Table height	620 - 800 mm
■ Table area (L x W)	950 x 500 mm
■ Angle table tray	0° - 18° - 36° - 54° - 72° - 90°

■ Height lower frame	215 mm
■ Free height above the floor	60 mm
■ Wheel diameter	50 mm
■ Weight	11,3 kg
■ Maximum table load	10 kg
■ Additional information	CE

# Alesia

## GERIATRIC CHAIR

The multifunctional chair Alesia offers a reclinable backrest with dual control for both the attendant and the user. The seat inclination and armrests are adjustable in combination with a retractable footplate.

The rear wheels have foot brakes to ensure safety during transfers or whilst remaining stationary. The seat cushion has been shaped to ensure maximum comfort.

Alesia comes with a wide range of options such as a serum holder and side supports, ... The chair is also available in a wide range of colors to suit your style or interior design.

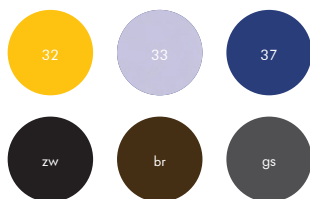

■ Total width	700 mm
■ Total length	800 mm
■ Total height	1330 mm
■ Seat width	540 mm
■ Seat height	530 mm
■ Seat angle	12°

■ Seat depth	480 mm
■ Backrest height	800 mm
■ Armrest height	0 - 270 mm
■ Weight	33 kg
■ Maximum user weight	140 kg
■ Additional information	CE

Measurements in mm and kg. Deviations in sizes and weight (15 mm and 1,5 kg) are possible. Subject to technical alterations. Images for illustration purposes only. Certain features may be optional.



VERMEIREN

# 690

## PLASTIC RAMPS

**Determine the height of the obstacle or step you need to overcome and choose a ramp set accordingly.** This modular system allows for an easy height-adjustable kit, suited for obstacles from 18mm up to 199mm. The maximum load is 200 kg for all sizes, small to extra-large.



690 - KIT 1



690 - KIT 2

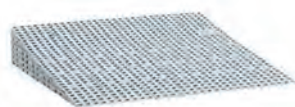

690 - KIT 3

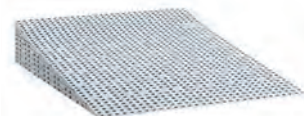

690 - KIT 4

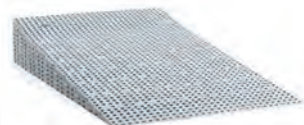

690 - KIT 5

■ KIT 1 - Total width / height / length	250 x 18-55 x 750 mm
■ KIT 2 - Total width / height / length	500 x 36-91 x 750 mm
■ KIT 3 - Total width / height / length	750 x 72-127 x 750 mm
■ KIT 4 - Total width / height / length	1000 x 108-163 x 750 mm
■ KIT 5 - Total width / height / length	1250 x 144-199 x 750 mm
■ Nominal load	200 kg

■ Weight KIT 1	1,3 kg
■ Weight KIT 2	4,3 kg
■ Weight KIT 3	9,2 kg
■ Weight KIT 4	15,8 kg
■ Weight KIT 5	20 kg
■ Additional information	CE

# 692

## FOLDING RAMPS

**Placing a scooter or a wheelchair in a car (for transport) becomes easy thanks to these ramps.**

These folding ramps make sure that you can safely place heavy scooters and wheelchairs in the car. Unpack, unfold and ready to use. The handles make it easy to move the ramps about and the non-slip surface ensures a better traction for the wheelchair or scooter.



Storage / transportation bags are included and each set contains two ramps.

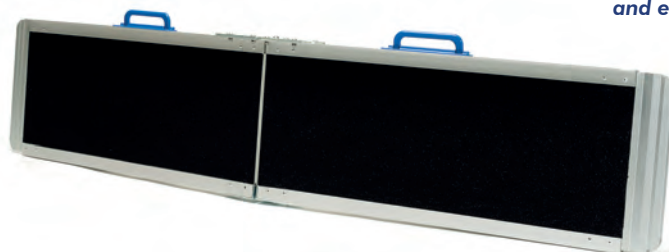

■ Total width	370 mm
■ Total length	1800 mm
■ Total height	50 mm
■ Weight (1 ramp)	9 kg
■ Nominal load (1 ramp)	150 kg
■ Additional information	CE



SCAN the QR code and discover our foldable ramps.



07

SCOOTERS



## SCOOTERS

One	127
One Air+	128
One Air+ Spring	129
Eris	130
Ceres	132
Ceres 4 Deluxe	133
Kuarz	134
Mercurius 4D	138
MOVO Raincover	140
Options	141

**We have a wide range of scooter available to suit everyone's needs.**

Discover our wide variety of indoor or outdoor scooters, or a combination of the best of both worlds.

All scooters also have a wide range of adjustable features to personalise the scooter even more.



# One

IN- & OUTDOOR  
SCOOTER



- 4 interchangeable colors
- Easy to disassemble for transport
- Width adjustable armrests
- Removable shopping basket with handle
- Angle adjustable steering column
- 360° Swivel chair

**One is a perfect compact and stylish scooter for in- and outdoor use. Adapted to your style and your lifestyle!**

Lightweight and compact in its form, One can be used for short daily trips to restaurants, stores or in small spaces. The scooter fully disassembles for compact travelling or storage. 4 unique colours

can be interchanged easily for a matching scooter to your style, at any time. Your One scooter comes with 4 fashionable colours included.



## Features



**Adjustable steering column**



**Anti-tipping wheels for extra safety**



**Pouch at the backrest to carry all your important documents**



**Easy to use and functional display**

## Technical information

■ Total width	490 mm
■ Total length	1030 mm
■ Total height	880 mm
■ Seat height	420 - 465 mm
■ Turning radius	1150 mm
■ Batteries	24V - 15Ah

■ Driving range*	16 km
■ Batteries	270 W
■ Speed*	8 km/h
■ Weight	44,9 kg
■ Maximum user weight	136 kg
■ Additional information	CE

\* The driving range is calculated according to European standards. \* Speed and driving range may deviate (ca. 15%). Permitted dimensional and weight tolerances: 15 mm, 1.5 kg and 1.5°.  
Subject to technical alterations. Images for illustration purposes only. Certain features may be optional.

# One AIR+

IN- & OUTDOOR  
SCOOTER



- Compact indoor scooter
- Perfect for daily trips
- Adapted to your style
- Air tires for smoother driving
- Bigger battery for a longer driving distance

**One Air+ has a similar design as the One but with a few enhancements towards comfort and power.** The air tires ensure a smoother and more comfortable drive while the bigger battery (25 Ah) results in a longer driving distance up to 30 km. Your One Air+ scooter comes with 4 interchangeable colours included. Easy to change without tools and adjustable to your own taste.



## Features



Adjustable steering column



Bigger battery for a longer driving distance



Comfortable driving with air tires



Fits in smaller cars

## Technical information

■ Total width	490 mm
■ Total length	1030 mm
■ Total height	880 mm
■ Seat height	420 - 465 mm
■ Turning radius	1150 mm
■ Batteries	24V - 25Ah

■ Driving range*	30 km
■ Batteries	270 W
■ Speed*	8 km/h
■ Weight	50 kg
■ Maximum user weight	136 kg
■ Additional information	CE

\* The driving range is calculated according to European standards. \* Speed and driving range may deviate (ca. 15%). Permitted dimensional and weight tolerances: 15 mm, 1.5 kg and 1.5°. Subject to technical alterations. Images for illustration purposes only. Certain features may be optional.

# One AIR+ SPRING

IN- & OUTDOOR  
SCOOTER



- Light and easy portable lithium battery
- Suspension at the bottom of the seat
  - Suspension on the rear wheels
- Angle adjustable steering column
- 360° Swivel chair
- Airtires

Experience ultimate comfort with the One Air+ Spring! The One Air+ Spring is the indoor scooter with a clever twist: thanks to the suspension seat, you'll enjoy extra comfort on every ride - whether you're driving around the house or making a quick trip to the store.

No bumps, no shocks, just smooth and stable riding pleasure. Discover the difference of suspension at its best!

## Features



Equipped with a lithium battery which ensures a lower weight



Shock absorbers on the wheels and suspension at the bottom of the seat provide a pleasant driving feel



## Technical information

■ Total width	490 mm
■ Total length	1030 mm
■ Total height	880 mm
■ Seat height	420 - 465 mm
■ Turning radius	1150 mm
■ Batteries	24V - 20Ah

■ Driving range*	26 km
■ Batteries	270 W
■ Speed*	8 km/h
■ Weight	42,35 kg
■ Maximum user weight	136 kg
■ Additional information	CE

\* The driving range is calculated according to European standards. \* Speed and driving range may deviate (ca. 15%). Permitted dimensional and weight tolerances: 15 mm, 1.5 kg and 1.5". Subject to technical alterations. Images for illustration purposes only. Certain features may be optional.



## Discover our scooters online!

Scan this code and discover more about **ERIS**.



### A POLYVALENT SCOOTER

Easily navigate indoor driving spaces thanks to the **compact size** and small turning radius. The Eris scooter is ideal for in- and outdoor use due to its driving comfort and crossing capacity.

### ADJUST YOUR SCOOTER TO YOUR DRIVE

Adjustable and foldable swivel seat, armrests, mirrors, lighting, turn signals, brake lights, front basket, adjustable steering column,... There are many features that are standard included in the Eris scooter. Change your scooter however you like.

### EXTREME DRIVING COMFORT

The many adjustments, but also the very **comfortable seat** ensure a comfortable drive on Eris. The suspension system allows for minimal shaking as well as the standard air tires.

# Eris

## OUTDOOR SCOOTER



- Removable basket
- Adjustable seat and backrest
- 2 rearview mirrors
- Adjustable steering column
- Swivel seat

The Eris scooter is your in- and outdoor scooter for short distances to the shop, friends or family. Complete with indicators and lighting in LED version. The shopping tray can be taken off so you can carry it with you when purchasing small items at your local grocery store. Available as 6 km/h and 10km/h version.



### Features



Adjustable swivel seat (height and depth). Foldable armrests adjustable in width



Storage bag at the backrest



Adjust the position of the steering column with ease



Easy-to-use control panel

### Technical information

Total width	570 mm
Total length	1185 mm
Total height	1150 mm
Seat height	450 - 500 mm
Turning radius	2900 mm
Batteries	2 x 12V - 38Ah/50Ah

Driving range*	30 - 37 km
Batteries	320 W
Speed*	6 km/h or 10 km/h
Weight	75 kg
Maximum user weight	140 kg
Additional information	CE

\* The driving range is calculated according to European standards. \* Speed and driving range may deviate (ca. 15%). Permitted dimensional and weight tolerances: 15 mm, 1.5 kg and 1.5°.  
Subject to technical alterations. Images for illustration purposes only. Certain features may be optional.

# Ceres

## OUTDOOR SCOOTER



- Adjustable steering column
- Adjustable and comfortable seat
- Removable shopping basket
- Bumper for durability
- Front and rear lighting with indicators



**CERES SE is an outdoor scooter with a striking desing, an ergonomic seat including a height adjustable headrest. Design and functionality go hand in hand for this scooter.**

Standard equipped with a adjustable backrest, seat depth and armrest adjustability in both height and width. Ceres SE offers a wide range of adjustment possibilities to have the most comfortable ride. The steering column includes an adjustment lever, removable shopping basket and two rearview mirrors.

**Drive safely thanks to the LED indicators and bright lights.**

### Features



*Adjustable backrest*



*Adjustable steering column*



*LED lights and reflectors*



*U-shaped handles  
Analog control panel*

### Technical information

■ Total width	620 mm
■ Total length	1300 mm
■ Total height	1280 mm
■ Seat height	450 - 500 mm
■ Turning radius	2800 mm
■ Batteries	2 x 12V - 38 Ah or 50Ah

■ Driving range*	30 - 48 km
■ Batteries	450 W or 650 W
■ Speed*	10 km/h or 15 km/h
■ Weight	106 kg
■ Maximum user weight	140 kg
■ Additional information	CE

\* The driving range is calculated according to European standards. \* Speed and driving range may deviate (ca. 15%). Permitted dimensional and weight tolerances: 15 mm, 1.5 kg and 1.5°. Subject to technical alterations. Images for illustration purposes only. Certain features may be optional.

# Ceres 4 DELUXE

OUTDOOR  
SCOOTER



12  
km/h

champagne

- Removable basket
- Adjustable seat and backrest
- Rearview mirror
- Adjustable steering column
- Foldable and height adjustable armrests

**Ceres 4 Deluxe offers a more luxurious drive with the same benefits of Ceres 4.** With stronger battery, streamlined design and its striking champagne color. Ceres 4 offers a comfortable drive. Ultimate driving comfort with a wide range of available accessories create a perfect scooter to suit its driver.



## Features



*Anti-tipping, front and rear lights and reflectors for optimal safety when driving in the dark.*



*Functional display with large buttons and Delta-shaped steering handles*



*Angle adjustable steering column for more personal driving comfort*

## Technical information

■ Total width	610 mm
■ Total length	1310 mm
■ Total height	1160 mm
■ Seat height	445 - 520 mm
■ Turning radius	2940 mm
■ Batteries	2 x 12V - 38Ah or 50Ah

■ Driving range*	30 - 40 km
■ Batteries	470 W
■ Speed*	12 km/h
■ Weight	94,7 kg
■ Maximum user weight	135 kg
■ Additional information	CE

\* The driving range is calculated according to European standards. \* Speed and driving range may deviate (ca. 15%). Permitted dimensional and weight tolerances: 15 mm, 1.5 kg and 1.5°. Subject to technical alterations. Images for illustration purposes only. Certain features may be optional.

EUROPEAN  
PRODUCT  
DESIGN  
AWARD™  
2025 WINNER



 YouTube

Scan the QR code  
and enjoy the KUARZ movie



Kuarz

OUTDOOR SCOOTER

# Kuarz

## DESIGNED WITH PRECISION

Our scooters are born from precision and pride, designed and built entirely in our own factories. Every element is thoughtfully crafted - no detail too small to matter. From the smooth feel of the steering column to the brightness of the LED lights, from the comfort of the adjustable chair to the quality of every nut and bolt, everything is scrutinised to perfection.



## TECHNIQUE IN DEPTH

When it comes to scooters, the technical details aren't just numbers, they're the keys to freedom on four wheels. The width and length decide whether you glide gracefully through doorways or have to do a 2-point turn in the hallway. These specifications make sure your ride is safe, comfy, and joyfully yours.

## CUSTOMIZE YOUR SCOOTER

Options are what turn a scooter from "just transport" into your scooter. Mirrors, rearview cameras, and rain covers aren't just accessories, they're little touches that make every ride smoother, safer, and more enjoyable. A dust cover keeps it looking sharp, while a rollator holder means your mobility always comes with you.





Scan the QR code  
and discover the KUARZ  
dedicated website



**Options from left to right:** MOVO rain/sun protection, set of mirrors, slick or studded tyres, colored hubcap matching your scooter color, topcase at the back, shopping basket at the front, storage protection cover, rearview camera

**EUROPEAN  
PRODUCT  
DESIGN  
AWARD™**  
2025 WINNER



# Kuarz

## OUTDOOR SCOOTER



- arctic green
- burgundy red
- cool grey
- mat gold
- olive green
- pearl orange



- SBS LED front lights: See and Be Seen  
Advanced LED light technology for increased safety when driving in low light conditions
- Comfortable and adjustable seat
- Top notch design
- Wide range of trendy colors

**A modern scooter is more than just a way to get from A to B - it's freedom, dignity, and style rolled into one.** With its sleek, trendy design, it's the kind of scooter you're proud to be seen on, whether you're meeting friends for coffee, heading out for a bit of shopping, or enjoying a leisurely afternoon in the park. It's about

moving through life with confidence, knowing you have the independence to go wherever you want, whenever you want. This isn't just mobility - it's a lifestyle upgrade, combining comfort, practicality, and a touch of flair that turns every trip into a little celebration of you.



**SBS LED front lights: See and Be Seen  
Advanced LED light technology  
for increased safety**

### Features



**Fully foldable and removable chair**



**Easy to use controller with clear and visible pictograms**



**Anti-tipping and reflectors for a better visibility and safety**



**Recharge your device on the go**

### Technical information

■ Total width	680 mm
■ Total length	1505 mm
■ Total height	1345 mm - 1395 mm
■ Seat height	480 - 530 mm
■ Turning diameter	3400 mm
■ Batteries	80 Ah (C20), 12V DC, non-spillable AGM battery

■ Driving range*	45 km
■ Motors	750 W
■ Speed*	15 km/h
■ Weight	158 kg
■ Maximum user weight	150 kg
■ Additional information	CE

\* The driving range is calculated according to European standards. \* Speed and driving range may deviate (ca. 15%). Permitted dimensional and weight tolerances: 15 mm, 1.5 kg and 1.5°. Subject to technical alterations. Images for illustration purposes only. Certain features may be optional.

# Mercurius 4D

OUTDOOR  
SCOOTER



15  
km/h

C59  
champagne

- Maximum speed 15km/h
- Swivel seat
- Adjustable tilt steering column
- Front rear lighting with indicators
- Inflatable tires & sports rims
- 80A batteries
- Armrests adjustable in width and height
- LCD screen
- Double USB connector

A stylish four-wheeled scooter that makes people look twice. The sporty rims, extra strong basket, stylish colour and its fashionable lights add to its look. The headrest and armrests are adjustable for ultimate personalisation. Mercurius has a maximum speed of up to 15km/h and comes standard with a 80 Ah battery.

## Features



Anti-tipping, front and rear lights and additional reflectors



Backrest pouch



LCD screen

## Technical information

■ Total width	680 mm
■ Total length	1440 mm
■ Total height	1360 mm
■ Seat height	470 - 495 mm
■ Turning radius	3740 mm
■ Batteries	2 x 12V - 80Ah

■ Driving range*	55 km
■ Batteries	1000 W
■ Speed*	15 km/h
■ Weight	116,75 kg
■ Maximum user weight	150 kg
■ Additional information	CE

\* The driving range is calculated according to European standards. \* Speed and driving range may deviate (ca. 15%). Permitted dimensional and weight tolerances: 15 mm, 1.5 kg and 1.5°. Subject to technical alterations. Images for illustration purposes only. Certain features may be optional.



# Never leave without your canopy

## Protected in all weather conditions

The ultimate 4 seasons canopy for mobility scooters



\* Compatible with scooter models Mercurius, Carpo and Ceres

### MOV0, a canopy for mobility scooters. REDESIGNED.

No matter the weather, the **Movo canopy** protects you first of all from the sun, but also from all weather conditions. Combining protective fabric against the rain, windshield and sun visor, it also protects against cold and wind. Easy to assemble, easy to install, and of impeccable design quality, the Movo canopy protects you from the sun, rain, cold and wind, while maintaining optimal ventilation in the cabin

### Maximize the use of your vehicle

#### A much longer season

Get your vehicle out earlier in the spring, and extend your mobility scooter season, thanks to its protection against cold and wind. Double your annual outings Increase your number of annual outings in uncertain weather. Don't be afraid of getting caught in the rain far away from home thanks to the retractable canopy, which can be adapted according to the weather.

### A canopy that turns into a cabin in an instant



Thanks to its retractable technology, it does not need to be lowered at all times. You can choose the position that suits you, depending on the weather. You therefore have the option: canopy and cabin option with the same product.



#### Super-fast installation

You can install or remove the Movo canopy in less than 10 seconds. It's ultra-quick.



#### Easy to assemble

A detailed assembly manual and an accurate assembly video are available on our website, so you will be able to assemble the canopy in less than 15 minutes. Once assembled, the installation can be completed in less than 10 seconds.



#### Compact design

The width of the Movo canopy is 74 cm, which allows it to fit through all openings, even small interior doors.



#### Ultralight

With a total weight of 8,7 kg (19 lbs), the Movo canopy can be installed easily by one person.

# Options

**VERMEIREN** offers a wide range of accessories for your scooter. From crutch holder to scooter cover, optimise your scooter use with a selection of our options.



**SW01 - Extra battery**



**SW03 - Luggage box**



**Movo - Raincover**



**SW06 - Rollator holder**



**SW07 - Spare tire**



**SW08 - Cover**



**SW09 - Windshield**



**SW31 - Crutch holder**



**SW74 Mirror**



**SW83 - Cannister holder**



**SW84 - Elevated footplate**



**Shopping basket**

	One One AIR <sup>+</sup>	Sedna Premium	Eris	Ceres	Carpo Carpo XD	Mercurius 4D
■ <b>SW01 - Extra battery</b>	●					
■ <b>SW03 - Luggage box</b>				●	●	●
■ <b>Movo - Raincover</b>				●	●	●
■ <b>SW06 - Rollator holder</b>				●	●	●
■ <b>SW07 - Spare tire</b>					●	
■ <b>SW08 - Cover</b>				●	●	●
■ <b>SW09 - Windshield</b>				●	●	
■ <b>SW31 - Crutch holder</b>	●		●	●	●	●
■ <b>SW74 - Mirror</b>	●		S	S	S	S
■ <b>SW83 - Cannister holder</b>				●	●	●
■ <b>SW84 - Elevated footplate</b>				●	●	●
■ <b>Shopping basket</b>	S		S	S	S	S

S = STANDARD option. Subject to technical alterations. Images for illustration purposes only.



08

LARGER SIZES



## LARGER SIZES

V100 XL	144
V300 XL	145
Eclips XXL	145
Forest 3+	147
Normandie XXL	148
9062 XXL	148
Altitude XXL / Coraille XXL	149
Goliat / Goliat Artro	150
Interval XXL	151

**We want to offer products for everyone, that's why we also design products for people who need a chair or a bed that goes beyond the standard measures and that guarantees them the same comfort and durability as the other products.**

# V100 XL

## LARGER SIZES

The model V100 XL is the base model of the V-series and perfect for multi-purpose usage.

A robust and solid steel wheelchair with a user weight of up to 170 kg with a wide range of options to personalize your wheelchair. 100% adaptable to you and your needs. The double cross offers additional stability and 3 seat depths, 3 seat heights, 3 armrests and 3 upholstery options are creating an extremely versatile wheelchair.



**170 KG**  
Maximum  
user weight



■ Total width	740 / 770 / 810 mm
■ Total length	1060 mm
■ Total height	890 - 950 mm
■ Folded width	375 mm
■ Seat width	530 / 560 / 600 mm
■ Seat height	470 - 530 mm

■ Seat depth	490 mm
■ Backrest height	380 mm
■ Armrest height	220 - 240 mm
■ Weight	21,4 kg
■ Maximum user weight	170 kg
■ Additional information	CE



# V300 XL

## LARGER SIZES

This wheelchair with double-cross frame can support a user up to 170 kg.

The V300 D XL offers natural seating comfort with a comfortable seat and adjustable back. Complete, foldable, detachable back and seat, height adjustable armrests and footrest and optional drum brakes for the attendant.

- Push bar
- Tension adjustable seat and backrest
- Seat cushion and backrest in black nylon
- Double cross for extra stability
- Foldable

**C59**  
champagne

**C80**  
blue



**170 KG**  
Maximum  
user weight

■ Total width	740 / 770 / 810 mm
■ Total length	1085 mm
■ Total height	840 - 930 mm
■ Folded width	350 mm
■ Seat width	530 / 560 / 600 mm
■ Seat height	440 - 530 mm

■ Seat depth	490 - 530 mm
■ Backrest height	400 mm
■ Armrest height	220 - 240 mm
■ Weight	21 kg
■ Maximum user weight	170 kg
■ Additional information	CE

# Eclips XXL

## LARGER SIZES

**Aluminum folding wheelchair with double cross-brace.** The Eclips XXL provides comfort thanks to its anatomical seat and backrest. This chair equipped with reinforced rear wheels can support a maximum weight of 250 kg. Easy transfers are possible thanks to its aluminium one-piece footplate.

- Anatomical seat and backrest
- Adjustable heel strap
- One-piece folding footplate
- Reinforced clothing protectors



**C27**  
blue



**250 KG**  
Maximum  
user weight

■ Total width	850 / 900 / 950 / 1000 mm
■ Total length	1140 mm
■ Total height	1070 mm
■ Folded width	375 mm
■ Seat width	600 / 650 / 700 / 750 mm
■ Seat height	530 mm

■ Seat depth	530 / 540 / 550 / 560 mm
■ Backrest height	620 mm
■ Armrest height	200 mm
■ Weight	>38,50 kg
■ Maximum user weight	250 kg
■ Additional information	CE

Measurements in mm and kg. Deviations in sizes and weight (15 mm and 1,5 kg) are possible. Subject to technical alterations. Images for illustration purposes only. Certain features may be optional.



# Forest 3+

POWERED WHEELCHAIR  
FOR LARGER SIZES



We offer more than 32 different colours. For more information, please check our website.

- Electrically powered seat and backrest reclining (simultaneously)
- 6km/h or 10 km/h version
- Reduced overall length



**250 KG**  
Maximum user weight

## Features



*Moving axle at the front allowing to cross slopes and obstacles while keeping the 4 wheels on the ground*



*SE09 - Optional controller for carer*

**Compact, solid and efficient. The FOREST 3+ is the ideal companion for users who are looking for a compact wheelchair for indoors and at the same time a high-performance model for outdoors. Strength, comfort and adaptability are the main features of the FOREST 3+.**

The front oscillating axle ensures that all four wheels contact the ground and ensures a smooth ride. The optional V-STAB technology allows the user to ride in a straight line, even on uneven terrain, without having to constantly compensate. The user will appreciate the comfort of the FOREST 3+ with its preformed padding and individual adjustment possibilities which make this seat highly adaptable.

## Technical information

■ Total width	705 / 720 / 760 / 820 / 870 mm
■ Total length	1145 - 1163 mm
■ Total height	1100 mm
■ Seat height	450 mm
■ Seat width	500 / 550 / 600 / 650 / 700 mm
■ Seat depth	450 - 550 mm

■ Batteries	2 x 12V / 80Ah - 350 W
■ Speed*	6 km/h / 10 km/h
■ Driving range*	49 km
■ Weight	134,35 kg
■ Maximum user weight	250 kg
■ Additional information	CE

Measurements in mm and kg. Deviations in sizes and weight (15 mm and 1,5 kg) are possible. \* The range is calculated according to European standards. \* Speed and range may deviate (ca. 15%). Subject to technical alterations. Images for illustration purposes only. Certain features may be optional.

# Normandie XXL

## LARGER SIZES

### Care chair with adjustable backrest and legrest

Possible as a fixed chair or for patient transport with four optional casters. The height adjustable armrests can be fully lowered for lateral transfers while the anatomically shaped and foam padded seat and backrest allow for fatigue-free sitting and resting.



**350 KG**  
Maximum  
user weight



■ Total width	890 mm
■ Total length	760 mm
■ Total height	1200 mm
■ Seat width	770 mm
■ Seat height	510 mm
■ Seat angle	13° / 40°

■ Seat depth	480 mm
■ Backrest height	780 mm
■ Armrest height	0 - 220 mm
■ Weight	37,75 kg
■ Maximum user weight	350 kg
■ Additional information	CE

# 9062 XXL

## LARGER SIZES

This classic toilet chair 9062 XXL is made out of soft artificial leather and a solid sturdy frame, offering optimal comfort and hygiene. The backrest and seat are hard-wearing combined with a qualitative and timeless design.



**175 KG**  
Maximum  
user weight



**C11**  
black  
*Plastic bucket with handle  
and removable lid*



■ Total width	760 mm
■ Total length	665 mm
■ Total height	835 mm
■ Seat height	500 mm
■ Seat width	600 mm
■ Seat depth	490 mm

■ Armrest height	390 mm
■ Weight	15 kg
■ Maximum user weight	175 kg
■ Additional information	CE

# Altitude XXL Coraille XXL

LARGER SIZES



- 5 point belt
- Adjustable seat height
- Directional wheels
- Seat reclining up to 40°

The Altitude and Coraille chairs in the XXL seat widths of 55 cm and 60 cm have a maximum load capacity of 150 kg.

The upholstery of the shell ensures pressure relief and increases seating comfort, even during prolonged use. The angle of the seat can be adjusted by an attendant and the angle-adjustable legrest can also be continuously adjusted by the user themselves.



- Removable safety belt  
- Detachable, adjustable headrest

Extra-large, sturdy front wheels

## Features



Option B52  
Drip holder



Option:  
378 table



## Technical information

■ Total width	800 mm
■ Total length	1150 mm
■ Total height	1280 - 1305 - 1330 mm
■ Seat width	550 / 600 mm
■ Seat height	570 - 595 - 620 mm
■ Seat angle	0° / 40°

■ Seat depth	510 mm
■ Backrest height	750 mm
■ Armrest height	230 mm
■ Weight	38 kg / 46 kg*
■ Maximum user weight	150 kg
■ Additional information	CE

Measurements in mm and kg. Deviations in sizes and weight (15 mm and 1,5 kg) are possible. Subject to technical alterations. Images for illustration purposes only. Certain features may be optional.

# Goliat

## LARGER SIZES

The Goliat is a 4-wheel rollator solid with a maximum user weight of 200 Kg. Equipped with a retaining strap, brakes with parking position and height-adjustable handles. It is possible to adjust its height at the level of the wheels at the front and at the rear. Completely collapsible, it is ideal for transport and storage. Its shopping bag can be removed if necessary.



■ Total width	650 mm
■ Total height	830 - 1020 mm
■ Total length	750 mm
■ Seat height	490 - 560 mm
■ Seat depth	410 mm
■ Seat width	470 mm

■ Brakes	multifunctional brakes with lock
■ Wheels	8"
■ Maximum load basket	5 kg
■ Weight	10,7 kg
■ Maximum user weight	200 kg
■ Additional information	CE

# Goliat Arthro

## HEAVY-DUTY ROLLATOR

Heavy-duty upright rollator with forearm supports. Goliat Arthro has a modern and strong design with height-adjustable forearm supports to relieve stress on hands and wrists whilst standing upright.

With a maximum user weight of 200 Kg and a wider frame, this rollator is an excellent choice for users who need extra stability and sturdiness when navigating. The forearm supports provide an upright position to relieve joints and improve posture.



■ Total width	650 mm
■ Total height	1140 - 1310 mm
■ Total length	750 mm
■ Seat height	490 - 560 mm
■ Seat depth	410 mm
■ Seat width	470 mm

■ Brakes	multifunctional brakes with lock
■ Wheels	8"
■ Maximum load basket	5 kg
■ Weight	12,35 kg
■ Maximum user weight	200 kg
■ Additional information	CE

# Interval XXL

LARGER SIZES

The Interval XXL bed 3 functions with adjustment electric existing in width 1200 or 1400 mm.

The bed is equipped with a white frame and a mesh base. The legrest comes with a manual knee-buckle

The Interval XXL bed is delivered assembled on its transport kit and only takes minutes to install your bed wherever you want it.



Controller with easy-to-use buttons and lock



Manual adjustment



Integrated matras support



**240 KG**  
Maximum user weight



white



Delivery kit with bed, ready to be assembled



Available with wooden barriers



## Technical information

■ Width/length/height	1330 x 2080 x 860 - 1295 mm
■ Height adjustment of the bed surface	370 - 805 mm
■ Mattress	1200 x 2000 x 120 mm
■ Weight	124 kg
■ Maximum user weight	275 kg*
■ Additional information	CE

■ Width/length/height	1530 x 2080 x 860 - 1295 mm
■ Height adjustment of the bed surface	370 - 805 mm
■ Mattress	1400 x 2000 x 120 mm
■ Weight	139 kg
■ Maximum user weight	240 kg
■ Additional information	CE

Measurements in mm and kg. Deviations in sizes and weight (15 mm and 1,5 kg) are possible. Subject to technical alterations. Images for illustration purposes only. Certain features may be optional.



09

TRICYCLES



## TRICYCLES

How to select my tricycle?	155
2202 Safari / Aqua	156
2215 Sporty / Happy	156
2217 Freedom black / white (E)	157
2219 Lagoon / Vintage (E)	157
Options	161

**VERMEIREN** is known to be one of the most reputable manufacturers of tricycles. Our products have been recently redesigned and will be perfectly adapted to all ages, all sizes and all pathologies. We also have a very large choice of options to further enhance your tricycle.



# How do I choose my tricycle?

The choice of the size of a tricycle is determined by the Total inside leg length (A) - (total distance, straight leg, from the folds of the groin to the heel). You must then compare this figure to the measurements ground-saddle and saddle pedal below.

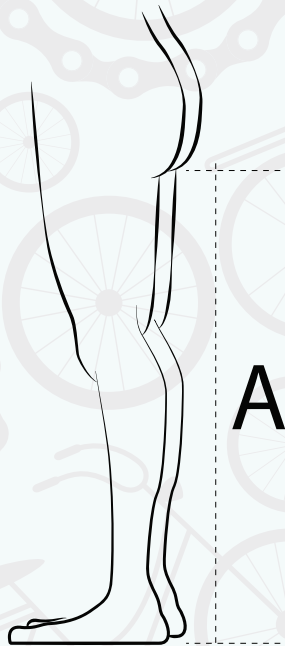

2202	2215	2217	2219
Distance ground-saddle <b>45,5 to 57 cm</b>	Distance ground-saddle <b>61 to 76 cm</b>	Distance ground-saddle <b>70,9 to 95 cm</b>	Distance ground-saddle <b>78,9 to 103 cm</b>
Distance saddle-pedal <b>34,5 to 47 cm</b>	Distance saddle-pedal <b>48 to 65 cm</b>	Distance saddle-pedal <b>58,6 to 82,7 cm</b>	Distance saddle-pedal <b>64 to 88 cm</b>
<b>3 years and above</b>	<b>8 years and above</b>	<b>14 years and above</b>	<b>adults</b>
models : <b>Aqua &amp; Safari</b>	models : <b>Happy &amp; Sporty</b>	models : <b>Freedom &amp; e-Tricycle</b>	models : <b>Lagoon Vintage &amp; e-Tricycle</b>

# What's the difference between a fixed-gear of a freewheel?

**FIXED-GEAR** tricycles have a single cog and chainring. The rear cog is bolted in place on the hub of the rear wheel. It cannot rotate independently from the wheel. In other words, there is no freewheel mechanism.

**SINGLE-SPEED** bikes are equipped with a freewheel mechanism. This allows the rear cog to rotate in one direction relative to the rear wheel but not the other. The cog can freely spin backward or stay in place while the rear wheel rolls forward.



# 2202 Safari

TRICYCLE - AGE 3 YEARS AND ABOVE

Tricycle 2202 for children with 12" tires in the color variant yellow/black (Safari) or blue/white (Aqua) with a low frame. Thanks to its extensive range of accessories, this tricycle is a reliable partner for therapeutic use.



■ Total width	648 mm
■ Total length	1110 mm
■ Total height	726 - 838 mm
■ Ground clearance	85 mm
■ Height frame tube	118 mm
■ Turning radius	2000 mm

# 2202 Aqua



■ Distance saddle-pedal	345 - 470 mm
■ Distance ground-saddle	455 - 570 mm
■ Wheels	12" x 2.00
■ Weight	14 kg
■ Maximum user weight	40 kg
■ Additional information	CE

# 2215 Sporty

TRICYCLE - AGE 8 YEARS AND ABOVE

Tricycle 2215 for children with 16" tires in the color variant pink/white (Happy) or black/red (Sporty) with low frame. With its extensive range of accessories, this tricycle is a reliable partner for therapeutic use.



■ Total width	648 mm
■ Total length	1294 mm
■ Total height	827 - 940 mm
■ Ground clearance	100 mm
■ Height frame tube	133 mm
■ Turning radius	2350 mm

# 2215 Happy



■ Distance saddle-pedal	480 - 650 mm
■ Distance ground-saddle	610 - 760 mm
■ Wheels	16" x 1.75
■ Weight	16,5 kg
■ Maximum user weight	60 kg
■ Additional information	CE

# 2217 Freedom

TRICYCLE - AGE 14 YEARS AND ABOVE

A tricycle for active young adults, available in black and white.

Perfect for a ride through the countryside.



Available in electric version

■ Total width	670 mm
■ Total length	1600 mm
■ Total height	986 - 1174 mm
■ Ground clearance	97 mm
■ Height frame tube	174 mm
■ Turning radius	2750 mm

■ Distance saddle-pedal	586 - 827 mm
■ Distance ground-saddle	709 - 950 mm
■ Wheels	20" x 1.75
■ Weight	25,5 kg
■ Maximum user weight	110 kg
■ Additional information	CE

# 2219 Lagoon / Vintage

ADULT

2219 tricycle with 24" tires in red or gray with a low frame. (brown for the Vintage model).

The perfect tricycle for long journeys, it offers stability and comfort and gives you complete freedom.



Available in electric version

■ Total width	768 mm
■ Total length	1808 mm
■ Total height	1121 - 1309 mm
■ Ground clearance	125 mm
■ Height frame tube	194 mm
■ Turning radius	3000 mm

■ Distance saddle-pedal	640 - 880 mm
■ Distance ground-saddle	789 - 1030 mm
■ Wheels	24" x 1 3/8"
■ Weight	27,8 kg
■ Maximum user weight	125 kg
■ Additional information	CE

Measurements in mm and kg. Deviations in sizes and weight (15 mm and 1,5 kg) are possible. Subject to technical alterations. Images for illustration purposes only. Certain features may be optional.

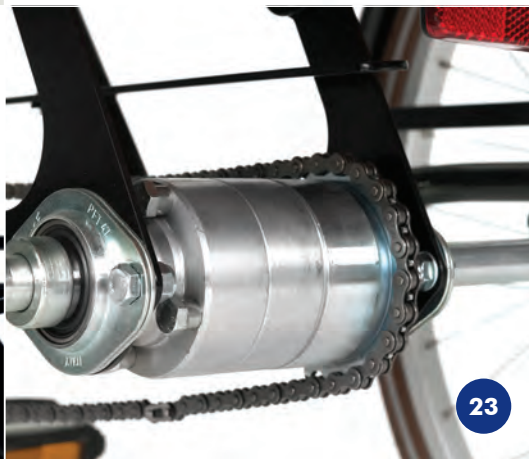
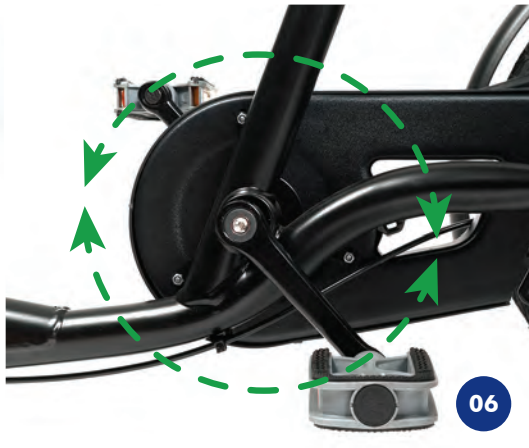



F2



F3



F4



F5



E1



E2



E2



E3



E4



E5



E6



E7



E8



E9



E10



E11



# OPTIONS TRICYCLES

## COMPATIBILITY LIST

		2202 Aqua Safari	2215 Happy Sporty	2217 Freedom	2219 Lagoon	2219 Vintage	e-Tricycle
<b>S1</b>	classic steering	●	●	●	●	-	-
<b>S2</b>	flat steering	●	●	●	●	-	-
<b>S3</b>	city steering	-	-	●	●	standard	standard
<b>S4</b>	rectangular steering	●	●	●	-	-	-
<b>S5</b>	adjustable steering bracket (-10° à +50°)	-	-	●	●	●	●
<b>S6</b>	extended steering (13cm)	●	●	standard	standard	standard	standard
<b>D1</b>	steering lock	●	●	●	●	●	●
<b>06</b>	fixed pinion	●	●	●	●	●	-
<b>01 + B1</b>	free pinion	-	-	●	●	●	●
<b>B1</b>	disc brake for the rear wheel	-	-	●	●	●	standard
<b>02</b>	torpedo brake	●	●	●	●	●	-
<b>03</b>	3 gears	-	●	●	●	●	●
<b>07</b>	7 gears	-	-	●	●	●	●
<b>23</b>	differential	-	-	-	●	●	-
<b>F1</b>	pedals with footstrap	●	●	●	●	●	●
<b>F2</b>	pedals with feet and toe strap	●	●	●	●	●	●
<b>F3</b>	foot support with self fasteners	●(s)	●(s)	●(m)	●(m)	●(m)	●(m)
<b>F4</b>	foot support + ankle holder with self fasteners	●	●	●	●	●	●
<b>F5</b>	adjustable pedal - 2 positions (22 mm)	-	●	●	●	●	●
<b>E1</b>	pushbar (335 mm or 605 mm)	●(s)	●(s)	●(m)	●(m)	●(m)	●(m)
<b>E2</b>	front and rear light	-	●	●	●	●	●
<b>E3</b>	odometer	-	●	●	●	●	●
<b>E4</b>	vintage basket	-	-	-	-	●	●
<b>E5</b>	top case	-	-	●	●	●	●
<b>E6</b>	crutch holder	-	-	●	●	●	●
<b>E7</b>	can holder (drinking can not included)	●	●	●	●	●	●
<b>E8</b>	mirror	●	●	●	●	●	●
<b>E9</b>	hand holding straps with self fasteners	●	●	●	●	●	●
<b>E10</b>	hand holding straps with self fasteners	●(s)	●(s)	●(m)	●(m)	●(m)	●(m)
<b>E11</b>	closed hand holder with self fasteners	●	●	●	●	●	●
<b>E12</b>	comfort saddle (PU + plastic)	-	-	●	●	●	●
<b>E13-D</b>	home trainer (home exercise system)	-	●	●	●	●	●
<b>E14</b>	front shopping basket	-	-	●	●	●	●
<b>BAT 9</b>	battery pack (9A)	-	-	-	-	-	●
<b>P1</b>	pelvic support	●(s)	●(s)	●(m)	●(m)	●(m)	●(m)
<b>P2</b>	back support	●(s)	●(s)	●(m)	●(m)	●(m)	●(m)
<b>P3</b>	pelvic and back support (P1+P2)	●(s)	●(s)	●(m)	●(m)	●(m)	●(m)
<b>P4</b>	depth adjustable saddle (140 mm)	●(s)	●(s)	●(m)	●(m)	●(m)	●(m)
<b>P5</b>	saddle tube with suspension	-	-	-	-	●	●

s : small / m : medium





## WALKING

250 / 253	164
265 / 266 / 267 / 268	164
275 / 276	165
Twin-Light / 286B	166
286i / Cadeo	166
Eco-Light II / ECO-Plus	167
Quadri-Light / Four-Light	167
Quava / Goliat	169

**To ensure the mobility of all we have many solutions consisting out of a wide range of rollators, walkers, canes ...**

In addition, **VERMEIREN** provides in a range of products designed to make everyday life easier such as bath stools, shower chairs and technical aids.

# 250

## LIFT AND PUSH

**Model 250 is a classic walker with two wheels in front and rubbers at the back. Complete with a seating pad and height-adjustable pushing handles. Lift at the rear and gently push and move forward. As such, you will use both your legs as well as your arms.**



■ Total width / length / height	480 x 550 x 715 - 915 mm
■ Seat width	400 mm
■ Seat height	620 mm
■ Weight	6,5 kg
■ Maximum user weight	100 kg
■ Additional information	CE

# 253

## COMPLETE PUSH-WALKER

**Model 253 is a complete walker with two wheels in front and rubbers at the back. Complete with a seating pad, height adjustable pushing handles, a plexi tray and a removable metal shopping basket. Lift at the rear and gently push and move forward. You will use both your legs as well as your arms.**



■ Total width / length / height	560 x 670 x 715 - 915 mm
■ Seat width	415 mm
■ Seat height	530 mm
■ Weight	4,6 kg
■ Maximum user weight	130 kg
■ Additional information	CE

# 265

## WALKING FRAME

**Tubular steel frame painted in blue.** Padded armpit supports which are adjustable in height. 4 wheels of 75 mm of which 2 with brake. Can be dismantled for easy transport and storage.



■ Total width / length / height	580 x 760 x 1170 - 1470 mm
■ Seat width	300 mm
■ Seat height	520 mm
■ Weight	13,7 kg
■ Maximum user weight	120 kg
■ Additional information	CE

# 266

## WALKING FRAME

**Tubular steel frame painted in blue.** Padded armpit supports which are adjustable in height. 4 wheels of 75 mm of which 2 with brake. Foldable for easy transport and storage.



■ Total width / length / height	580 x 760 x 1170 - 1470 mm
■ Seat width	275 mm
■ Seat height	520 mm
■ Weight	12,5 kg
■ Maximum user weight	120 kg
■ Additional information	CE

# 267

## WALKING FRAME

Model 267 has the same features as the 265 with the addition of the adjustment of the base height up to 150 mm.

C27  
blue



■ Total width / length / height	580 x 760 x 1115 - 1560 mm
■ Seat width	300 mm
■ Seat height	465 - 610 mm
■ Weight	14 kg
■ Maximum user weight	120 kg
■ Additional information	CE

# 268

## WALKING FRAME WITH TABLE

Tubular steel frame painted in blue. Padded arm support adjustable in height. 4 wheels of 75 mm of which 2 with brake. Can be dismantled for easy transport and storage.

C27  
blue



■ Total width	580 mm
■ Total length	760 mm
■ Total height	830 - 1130 mm
■ Weight	15,5 kg
■ Maximum user weight	120 kg
■ Additional information	CE

# 275

## FOLDABLE 4 WHEELS WALKER

The 275 guarantees you excellent support in the event of gait instability. Four wheel rollator, foldable, with padded seat and back support, shopping basket and storage tray.

grey



■ Total width/length/height	590 x 750 x 820-950 mm
■ Seat width	440 mm
■ Seat height	570 mm
■ Weight	8,8 kg
■ Maximum user weight	120 kg
■ Additional information	CE

# 276

## WALKER WITH FOREARM SUPPORT

The 276 with forearm supports guarantees excellent support in case of difficulty in walking. A foldable four-wheeled walker, with padded seat and back, seat and back support, shopping basket and retractable tray under the seat.

grey



■ Total width/length/height	630 x 750 x 1030-1150 mm
■ Seat width	440 mm
■ Seat height	570 mm
■ Weight	11 kg
■ Maximum user weight	120 kg
■ Additional information	CE

Measurements in mm and kg. Deviations in sizes and weight (15 mm and 1,5 kg) are possible. Subject to technical alterations. Images for illustration purposes only. Certain features may be optional.

# Twin-Light

## 2 WHEELS ROLLATOR

**Twin-Light is a new 2-wheel rollator in the VERMEIREN range.** Ultra-lightweight, easy to fold and store. Ergonomic handles are adjustable in height up to 950 mm and its maximum user weight is 130 kg.



■ Total width/length/height	570 x 570 x 760-950 mm
■ Seat width	390 mm
■ Seat height	540 mm
■ Weight	3 kg
■ Maximum user weight	130 kg
■ Additional information	CE

# 286B

## COMPLETE ROLLATOR

**Model 286 B is a 4-wheel foldable rollator equipped with a removable basket, removable plexiglass table, seat and crutch holder.** Complete with parking brakes and height adjustable handles. It comes with a very simple and fast folding system that allows easy transport and storage.



■ Total width/length/height	605 x 645 x 770 - 1010 mm
■ Folded width	270 mm
■ Seat height	610 mm
■ Weight	9,5 kg
■ Maximum user weight	130 kg
■ Additional information	CE

# 286i

## FOLDABLE 4 WHEELS WALKER

**Foldable 4 wheel rollator. Equipped with a removable transport basket, a plexi-tray-tablet, a seat and a cane holder.** Parking brakes and height-adjustable handles. Folding model thanks to a very simple and very fast system.



■ Total width/length/height	600 x 680 x 780-990 mm
■ Seat width	420 mm
■ Seat height	560 mm
■ Weight	9,85 kg
■ Maximum user weight	130 kg
■ Additional information	CE

# Cadeo

## ULTRA LIGHT

**The Cadeo rollator is a 4-wheel foldable rollator. Equipped with a removable shopping bag and a padded seat.** A foldable bar provides extra support when seated. Free walking around and stops when you use your bodyweight to push the Cadeo downwards. Easy to fold and carry with you in public transport.



■ Total width/length/height	625 x 640 x 810 - 895 mm
■ Seat width	350 mm
■ Seat height	540 mm
■ Weight	4,6 kg
■ Maximum user weight	90 kg
■ Additional information	CE

# Eco-Light II

FOLDABLE 4 WHEELS ROLLATOR

The Eco-Light II is a foldable rollator with 4 wheels, equipped with a removable basket, a padded seat and a crutch holder. A collapsible bar offers additional support while seated. Complete with parking brakes and height-adjustable handles.



champagne

■ Total width/length/height	615 x 695 x 800-930 mm
■ Seat width	355 mm
■ Seat height	560 mm
■ Weight	7,5 kg
■ Maximum user weight	120 kg
■ Additional information	CE

# ECO-Plus

HEIGHT ADJUSTABLE SEAT

The Rollator EcoPlus is a 4-wheel rollator with the feature of having an adjustment on the front and the back allowing to adjust the height of his seat. Equipped with a net, a foam cushion and a cane holder. A support belt provides additional comfortable support when seated.



silver grey

blue

■ Total width/length/height	610 x 680-795 x 845-1020 mm
■ Seat width	360 mm
■ Seat height	555 - 625 mm
■ Weight	7,5 kg
■ Maximum user weight	136 kg
■ Additional information	CE

# Quadri-Light

ULTRA LIGHT

A 4-wheel, folding, lightweight aluminum rollator with brakes is ideal for people with an irregular stride but able to brake when they feel slightly off balance. A seat and a support strap allow the user to rest after long use.



grey

red

■ Total width/length/height	650 x 700 x 805-930 mm
■ Seat width	450 mm
■ Seat height	610 mm
■ Weight	7,25 kg
■ Maximum user weight	130 kg
■ Additional information	CE

# Four-Light

REFRESHED

The Four-light has been updated and refreshed into an elegant, more trendy 4-wheel rollator. Available now in a sleek carbon grey design and complete with parking brakes, back belt support, a shopping net, and a crutch holder. The handles are adjustable in height and the Four-Light is easily foldable for smooth and convenient transport.



carbon grey

■ Total width/length/height	660 x 750 x 870-990 mm
■ Seat width	450 mm
■ Seat height	550 mm
■ Weight	8,45 kg
■ Maximum user weight	130 kg
■ Additional information	CE

Measurements in mm and kg. Deviations in sizes and weight (15 mm and 1,5 kg) are possible. Subject to technical alterations. Images for illustration purposes only. Certain features may be optional.



# Quava

## COMPACT FOLDABLE ROLLATOR

Quava is a modern, lightweight, foldable rollator with multifunctional brakes. Ideal for the car, travel, errands or for shopping. Thanks to the wide padded back belt you can easily sit down when the brakes are locked.



■ Total width	655 mm
■ Total height	830 - 955 mm
■ Total length	710 mm
■ Seat width	450 mm
■ Seat height	540 mm
■ Folded width	280 mm

■ Seat depth	225 mm
■ Turning radius	895 mm
■ Wheels	200 x 35 mm
■ Weight	7,05 kg
■ Maximum user weight	136 kg
■ Additional information	CE

# Goliat

## HEAVY DUTY

The Goliat is a new 4-wheel rollator solid with a maximum user weight of 200 Kg. Equipped with a retaining strap, brakes with parking position and height-adjustable handles. It is possible to adjust its height at the level of the wheels at the front and at the rear. Completely collapsible, it is ideal for transport and storage. Its shopping bag can be removed if necessary.



■ Total width	650 mm
■ Total height	830 - 1020 mm
■ Total length	750 mm
■ Seat width	470 mm
■ Seat height	490 - 560 mm
■ Folded width	650 mm

■ Seat depth	410 mm
■ Turning radius	1050 mm
■ Wheels	200 x 35 mm
■ Weight	10,7 kg
■ Maximum user weight	200 kg
■ Additional information	CE

Measurements in mm and kg. Deviations in sizes and weight (15 mm and 1,5 kg) are possible. Subject to technical alterations. Images for illustration purposes only. Certain features may be optional.





## HYGIENE - TECHNICAL AIDS

Pluo	172
9062 - 9063	173
139 / 175 Bis	173
9300 / 9301 / 9302 / 9303	174
Stacy /Jinny	176
Lilly / Jill	176
Laly / Kate	177
Vera /Vicky	177
Magda / Paris	178
Grace / Ivy	179
Liddy / Iris	179
Mia / Tina	180
260 / 264	180
640 / Izzie / Kim	181

**We also provide in a wide range of products designed to make everyday life easier** such as bath stools, shower chairs and a wide range of accessories.



# Pluo

## SHOWER AND COMMODE CHAIR

white

### OPTIONS

- Comfort seat
- Comfort backrest
- Gel cushions
- Lateral support
- Adjustable headrest
- Safety belt
- Safety rail

The chair Pluo functions both as a shower chair and a commode chair. Pluo is available with 5-inch wheels with brakes or with 24-inch rear wheels. The chair is easy to clean and transport. The foldable armrest and depth-adjustable footrest facilitate easy transfers. The footrest can be folded under the chassis to help with transfers. It has a removable hygiene bucket.

Model with 24" wheels



Lateral support



Bucket with handle



Safety rail



Removable gel cushion



Height adjustable seat



Comfort seat in PU



Safety belt



Adjustable headrest



Comfort backrest in PU



Brakes on all 4 wheels

### Technical information

■ Total width	570 mm / 668 mm*
■ Total length	720-785 mm / 910-975 mm*
■ Total height	1035 mm
■ Seat width	480 mm
■ Armrest height	225 mm
■ Seat height	515 mm

■ Backrest height	920 mm
■ Seat depth	450 mm
■ Bucket volume	9,3 liters
■ Weight	9,7 kg / 14 kg*
■ Maximum user weight	150 kg
■ Additional information	CE

\* Pluo equipped with 24" wheels. Measurements in mm and kg. Deviations in sizes and weight (15 mm and 1,5 kg) are possible. Subject to technical alterations. Images for illustration purposes only. Certain features may be optional.

# 9062

## COMMODE CHAIR

This classic toilet chair with artificial leather upholstery provides comfort and hygiene. Also available in XXL



blue upholstery

black upholstery

grey frame

# 9063

## COMMODE CHAIR (height adjustable)

Similar to the toilet chair 9062, but with additional height adjustable legs. For a more comfortable seating, the chair is slightly tilted backwards.



blue upholstery

black upholstery

grey frame

Total width/length/height	620 x 650 x 835 mm
Seat width	430 mm
Seat depth	450 mm
Weight	8,35 kg
Maximum user weight	120 kg
Additional information	CE

Total width/length/height	620 x 650 x 755-885 mm
Seat width	430 mm
Seat height	470 - 560 mm
Weight	9 kg
Maximum user weight	120 kg
Additional information	CE

# 139

## COMMODE CHAIR

C27  
blue

Model 139 is a high-quality wheeled commode chair combining easy-to-clean upholstery with a reliable and sturdy frame.

The one-handed bucket action makes care more hygienic and efficient for the attendant. The swing-away armrests facilitate easy transfer.



Total width/length/height	560 mm x 820 mm x 950 mm
Seat width	420 mm
Seat height	528 mm
Weight	13 kg
Maximum user weight	120 kg
Additional information	CE

# 175 bis

## COMMODE CHAIR

C86  
carbon grey

The 175 bis is a classic revamped fixed commode chair. Updated to a modern carbon grey color, extra soft padding on the seat, backrest and armrests. Under the padded cover is a nice, warm wooden seat for comfort and a totally enclosed recipient.



Total width/length/height	585 mm x 565 mm x 810 mm
Seat width	470 mm
Seat height	484 mm
Weight	9,35 kg
Maximum user weight	95 kg
Additional information	CE

Measurements in mm and kg. Deviations in sizes and weight (15 mm and 1,5 kg) are possible. Subject to technical alterations. Images for illustration purposes only. Certain features may be optional.

# 9300

## COMMODE WHEELCHAIR (large rear wheels)

The 9300 comes with an anatomically shaped back, a reclinable and removable middle part of the seat, removable rear wheels in PU, directional front wheels, and manual brakes on the rear wheels. The chair is available in multiple seat widths.



■ Total width	660 mm
■ Total length	1100 mm
■ Total height	1070 mm
■ Folded width	n/a
■ Seat width	430 / 530 mm
■ Armrest height	260 mm

■ Seat height	500 mm
■ Backrest height	580 mm
■ Seat depth	450 mm
■ Weight	25,5 kg
■ Maximum user weight	100 kg
■ Additional information	CE

# 9301

## COMMODE WHEELCHAIR (large front wheels)

The 9301 has an anatomical shaped back, reclinable and removable middle part of the seat, removable front wheels 24x1 3/8 PU, directional rear wheels 200x50 PU soft and manual brakes on the front wheels. There are multiple seat widths available.



■ Total width	660 mm
■ Total length	890 mm
■ Total height	1070 mm
■ Folded width	n/a
■ Seat width	430 / 530 mm
■ Armrest height	260 mm

■ Seat height	500 mm
■ Backrest height	580 mm
■ Seat depth	450 mm
■ Weight	26,5 kg
■ Maximum user weight	100 kg
■ Additional information	CE

# 9302

## COMMODE WHEELCHAIR (200 mm wheels)

The 9302 wheelchair has an anatomically shaped back, a reclinable and removable middle part of the seat, 4 wheels of 200x50 PU with two swivel wheels at the rear. There are different seat widths available.

C29  
grey



L06 Headrest



L55 Headrest



B22  
Spreader



B12  
Table



B15 Table



■ Total width	620 mm
■ Total length	840 mm
■ Total height	1070 mm
■ Folded width	n/a
■ Seat width	430 / 530 mm
■ Armrest height	260 mm

■ Seat height	500 mm
■ Backrest height	580 mm
■ Seat depth	450 mm
■ Weight	24,5 kg
■ Maximum user weight	100 kg
■ Additional information	CE

# 9303

## COMMODE WHEELCHAIR (100 mm wheels)

The 9303 commode wheelchair has an anatomically shaped backrest, a reclinable and removable middle part of the seat. There are 4 wheels of 100mm, with brakes on the rear.

C29  
grey



L06 Headrest



L55 Headrest



B22 Spreader



B12 Table



B15 Table



■ Total width	560 mm
■ Total length	850 mm
■ Total height	1070 mm
■ Folded width	n/a
■ Seat width	430 / 530 mm
■ Armrest height	260 mm

■ Seat height	500 mm
■ Backrest height	580 mm
■ Seat depth	450 mm
■ Weight	23,5 kg
■ Maximum user weight	100 kg
■ Additional information	CE

Measurements in mm and kg. Deviations in sizes and weight (15 mm and 1,5 kg) are possible. Subject to technical alterations. Images for illustration purposes only. Certain features may be optional.

# Stacy

## TOILET AID

With its adjustable legs, the toilet aid Stacy can be placed above or below the toilet seat to adjust to your needs.



white



Width /Length	570 x 550 mm
Total height	830 - 950 mm
Seat width	450 mm
Weight	8,6 kg
Maximum user weight	130 kg
Additional information	CE

# Jinny

## SHOWER STOOL

This multifunctional shower stool is a great addition to your bathroom for added stability or as a place to rest.



white

blue



Total width	350 mm
Total length	350 mm
Seat height	330 - 510 mm
Weight	1,5 kg
Maximum user weight	150 kg
Additional information	CE

# Lilly

## Shower chair

The antislip feet and seat and backrest of Lilly add extra security when used in a bathroom.



white

blue



Total width	510 mm
Total length	510 mm
Seat height	360 - 460 mm
Weight	3 kg
Maximum user weight	150 kg
Additional information	CE

# Jill

## SHOWER STOOL

The antislip feet and seat of Jill add extra security when used in a bathroom.



white

blue



Total width	510 mm
Total length	420 mm
Seat height	350 - 530 mm
Weight	2 kg
Maximum user weight	150 kg
Additional information	CE

# Laly

## SHOWER CHAIR

Laly is a comfortable shower chair with an anti-slip surface to ensure safe and hygienic showers.

The height can be adjusted depending on your individual needs.



# Kate

## TRANSFER BATH SEAT

Its non-slip surface of Kate is an added bonus in a wet environment such as a bathroom.

The handle can be mounted on the right or left depending on the placement of your bath



■ Total width	540 mm
■ Total length	580 mm
■ Seat height	430 - 530 mm
■ Weight	3,8 kg
■ Maximum user weight	130 kg
■ Additional information	CE

■ Total width	830 mm
■ Total length	610 mm
■ Seat height	470 - 580 mm
■ Weight	4,5 kg
■ Maximum user weight	150 kg
■ Additional information	CE

# Vera

## TRANSFER BOARD

360° degrees transfer board with drainage holes.



# Vicky

## TRANSFER BOARD

Vicky is a transfer board just like Vera. Compatible with most bath tubs. Although this transfer board does not have the drainage holes, it still allows for easy transfer into the bath.



■ Total width	350 mm
■ Total length	730 mm
■ Diameter turning disc	325 mm
■ Weight	3,75 kg
■ Maximum user weight	130 kg
■ Additional information	CE

■ Total width	350 mm
■ Total length	730 mm
■ Total height	175 mm
■ Weight	2,65 kg
■ Maximum user weight	135 kg
■ Additional information	CE

Measurements in mm and kg. Deviations in sizes and weight (15 mm and 1,5 kg) are possible. Subject to technical alterations. Images for illustration purposes only. Certain features may be optional.

# Magda

## SWIVEL BATH SEAT

**Bath seat with swivel function (up to 360°) in either direction.** This bath seat has an anti-slip seat that is easy to clean, provides extra security and compatible with most bathtubs in the market.



■ Total width	535 mm
■ Total length	735 - 785 mm
■ Total height	530 mm
■ Seat depth	360 mm
■ Seat width	440 mm
■ Height backrest	370 mm

■ Inside width of the bathtub	560 - 660 mm
■ Weight	6,65 kg
■ Maximum user weight	130 kg
■ Additional information	CE

# Paris

## SWIVEL BATH SEAT

**This high-end bath tub swivel gives you perfect safety and stability.** Non-slip surface material and quality frame for extra durability.



■ Total width	721 mm
■ Total length	515 mm
■ Total height	560 mm
■ Seat depth	410 mm
■ Seat width	370 mm
■ Height backrest	325 mm

■ Inside width of the bathtub	560 - 660 mm
■ Disassembled height	235 mm
■ Weight	6,65 kg
■ Maximum user weight	130 kg
■ Additional information	CE

# Grace

## SHOWER SEAT – WALL MOUNTED

The foldable shower chair Grace is a perfect choice for a compact and hygienic shower chair. The wall plate attachment ensures additional security and stability. Adjust and adapt the seat to individual needs with its height and adjustable feet.



■ Total width	510 mm
■ Total length	510 mm
■ Seat height	360 - 460 mm
■ Weight	3 kg
■ Maximum user weight	150 kg
■ Additional information	CE

# Ivy

## BATH GRAB RAIL

Functional and robust, this grab rail for your bath is an excellent added feature to your bathroom. Ivy is easy and fast to install thanks to the tool-free system. The attachment foot can be adjusted to most bath tubs.



■ Total width	180 mm
■ Total length	230 mm
■ Total height	480 mm
■ Weight	1,68 kg
■ Maximum load	130 kg
■ Additional information	CE

# Liddy

## TOILET FRAME

Liddy is a simple, yet effective toilet frame for extra support when getting on and off the toilet. Easy to install and to maintain.



■ Total width	560 - 660 mm
■ Total length	470 mm
■ Total adjustable height	630 - 740 mm
■ Weight	1,45 kg
■ Maximum user weight	113 kg
■ Additional information	CE

# Iris

## GRAB RAIL

The foldable grab rail Iris provides extra support in and around the bathroom. The integrated toilet paper holder ensures easy access in a safe space in the bathroom.

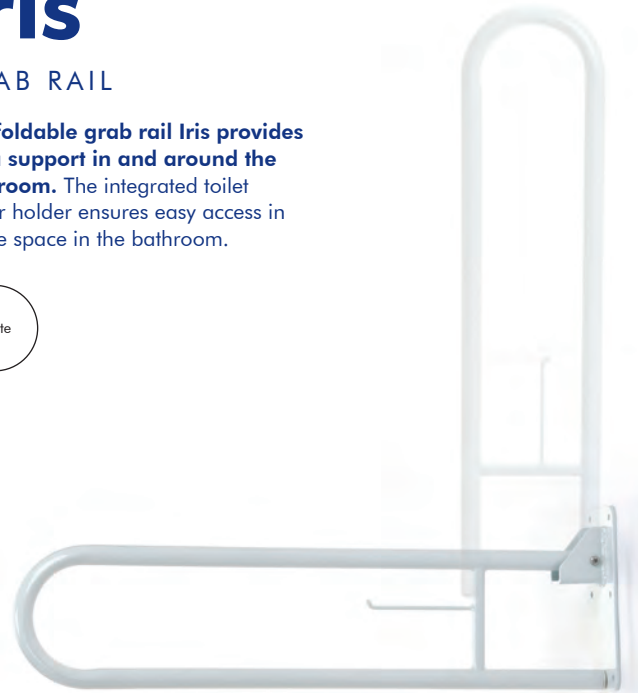

■ Total width	100 mm
■ Total length	740 mm
■ Total height	230 mm
■ Weight	1,8 kg
■ Maximum load	130 kg
■ Additional information	CE

Measurements in mm and kg. Deviations in sizes and weight (15 mm and 1,5 kg) are possible. Subject to technical alterations. Images for illustration purposes only. Certain features may be optional.

# Mia

## RAISED TOILET SEAT

This comfortable toilet seat raiser (available in different heights) is compatible with most toilets.

Installation can be done without extra tools. There is also an optional rubber cover available for added comfort.



# Tina

## RAISED TOILET SEAT WITH ARMRESTS

Tina is ergonomically designed to provide hygienic and comfortable visits to the bathroom. This toilet seat fits most toilets. The armrests and the added height provide extra stability when getting up.



■ Total width	365 mm
■ Total length	405 mm
■ Total height	100 mm / 150 mm
■ Weight	1,3 kg / 1,45 kg
■ Maximum user weight	225 kg
■ Additional information	CE

■ Total width	510 mm
■ Total length	510 mm
■ Seat height	340 - 440 mm
■ Weight	2,8 kg
■ Maximum user weight	150 kg
■ Additional information	CE

# 260

## QUAD CANE

Fitted with four non-slip cane tips, the 260 quad cane can stand on its own completely independently.

The cane provides more stability than a regular cane. Adjust its height to adapt to your length and needs.



# 264

## QUAD CANE

Just like the 260 quad cane, the 264 cane provides extra stability to its user with the added bones of a swanneck shaped handle. The swanlike form allows for even better weight distribution.



■ Total width	224 mm
■ Total length	335 mm
■ Total height	673 - 870 mm
■ Weight	1,4 kg
■ Maximum user weight	100 kg
■ Additional information	CE

■ Total width	232 mm
■ Total length	383 mm
■ Total height	805 - 953 mm
■ Weight	1,5 kg
■ Maximum user weight	100 kg
■ Additional information	CE

# 640

## TOILET AID

**640 is suitable as an assistive product for elderly people or people during recovery.** The aid provides extra support, making it easier to sit down and get up. It is also height adjustable as to fit your personal preferences.

**C29**  
grey



■ Total width	590 mm
■ Total length	420 mm
■ Total height	645 - 755 mm
■ Weight	4,2 kg
■ Maximum user weight	120 kg
■ Additional information	CE

# Izzie

## BATHROOM HANDLES

**Bathroom handles are available in different lengths from 300 mm to 800 mm.** Ideal as supports for additional safety in wet environments.

white



■ Total length	300 - 400 - 450 - 600 - 800 mm
■ Distance between bar and wall	40 mm
■	
■	
■ Maximum load	130 kg
■ Additional information	CE



# Kim

## PEDALO WITH DIGITAL DISPLAY

**Staying active at home is made easy with this pedalo.** The foldable design allows for compact storage. Track your progress with the included calorie counter.

blue



■ Total width	395 mm
■ Total length	500 mm
■ Disassembled height	160 mm
■ Weight	2,3 kg
■ Maximum load	50 kg
■ Additional information	CE



Version: February 2026

All rights reserved, including translations.

No part of this manual may be reproduced in any form what so ever (print, photocopy, microfilm or any other process) without written permission of the publisher, or processed, duplicated or distributed by using electronic systems.

**VERMEIREN** GROUP

